

TROUBLESHOOTING AND REPAIR INSTRUCTIONS

AIR HEATER 8 L

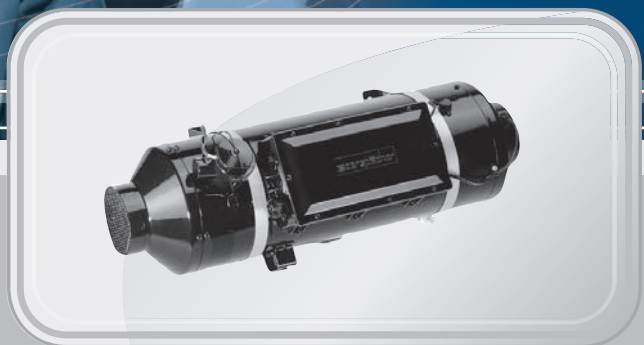

THE TROUBLESHOOTING AND REPAIR INSTRUCTIONS ARE ONLY VALID FOR THE FOLLOWING ENGINE-INDEPENDENT AIR HEATERS

Heaters for diesel

Heater version

D8LC – 12 V 25 1890 05 00 00

D8LC – 24 V 25 1891 05 00 00

CONTENTS

CONTENTS

This list of contents gives you precise information about the contents of the Troubleshooting and Repair Instructions.

If you are looking for a term, technical term or you would like an abbreviation explained, please use the relevant index at the end of the instructions.

CHAPTER	TITLE	CONTENT	PAGE
1	Introduction	Foreword	4
		Special text structure, presentation and picture symbols	4
		Heater documentation	4
		Further documentation	4
		Safety instructions for installation and repair	5
		Liability claim / Warranty	5
		Accident prevention	5
		Initial start-up of the heater or functional test after a repair	5
		Emergency shutdown – EMERGENCY OFF	5
2	Function and operation	Cutaway view	6
		Functional description	7
		Control and safety devices	7
3	Technical data	Air heater 8 L	9
		Control values	10
		Temperature sensor diagram	10
		Flame sensor diagram	10
4	Troubleshooting	What to check first in case of faults	11
		Use the control unit to call the diagnostic signals	11
		Overview of the test equipment and control units	12
		Fault diagnosis using the diagnostic unit	13
		Fault diagnosis with the EDiTH Basic diagnostic tool	15
		Fault diagnosis using the module timer	16
		Fault diagnosis using the radio remote control TP5	17
		Fault diagnosis with EasyStart R ⁺ and EasyStart T	18
5	Repair instructions	Repair work	21
		Safety instructions to be noted and followed before working on the heater	21
		Parts list for assembly drawing	21
		Assembly drawing	22
		Contents and page references for repair steps 1-15	23
		View of complete unit	23
		Repair steps 1 – 15	24
		Measuring the fuel quantity	34

CONTENTS

6	Electrics	Page references for the circuit diagrams	35
		Parts list, heater 8 L circuit diagram	35
		Heater 8 L circuit diagram	36
		Parts list, circuit diagrams, control units	37
		Circuit diagram for control units	38
		Parts list for circuit diagram of EasyStart R+ / R / T control units	43
		Circuit diagram for EasyStart R+ control unit	44
		Circuit diagram for EasyStart R+ control unit	45
		Circuit diagram for EasyStart R control unit	46
		Circuit diagram for EasyStart R control unit	47
		Circuit diagram for EasyStart T control unit	48
		Circuit diagram for EasyStart T control unit	49
		Circuit diagram for Calltronic (Version II from 2010)	50
7	Service	Certifications	51
		Disposal	51
		EC Declaration of Conformity	51
		List of abbreviations	52

1 INTRODUCTION

FOREWORD

These Troubleshooting and Repair Instructions are applicable to the heaters listed on the title page, to the exclusion of all liability claims. Depending on the version or revised status of the heater, there may be differences between it and these troubleshooting and repair instructions.

The user must check this before carrying out the repair work and, if necessary, take the differences into account.

SPECIAL TEXT STRUCTURE, PRESENTATION AND PICTURE SYMBOLS

Special text formats and picture symbols are used in these instructions to emphasise different situations and subjects. Please refer to the following examples for their meanings and appropriate action.

SPECIAL TEXT FORMATS AND PRESENTATIONS

- This dot (▪) indicates a list, which is introduced by a heading.
 - If an indented dash (–) follows a “dot”, this list is a sub-section of the black dot.

[Underlined blue text](#) denotes a cross-reference, which can be clicked in the PDF format. The part of the document named in the text is then displayed.

PICTURE SYMBOLS



DANGER!

This information points out a potential serious or fatal danger. Ignoring this information can result in severe injuries.

- This arrow indicates the appropriate precaution to take to avert the danger.
-



ATTENTION!

This information points out a dangerous situation for a person and / or the product. Ignoring this information can result in personal injuries and / or damage to the unit.

- This arrow indicates the appropriate precaution to take to avert the danger.
-



PLEASE NOTE!

These remarks contain recommendations for use and useful tips for the operation, installation and repair of the heater.

HEATER DOCUMENTATION

CONTENT AND PURPOSE OF THESE TROUBLESHOOTING AND REPAIR INSTRUCTIONS

These instructions are to be used to correct faults and to perform repairs on the heater. The work required for this may only be done by personnel appropriately trained by a JE service partner.

FURTHER DOCUMENTATION

TECHNICAL DESCRIPTION, INSTALLATION, OPERATING AND MAINTENANCE INSTRUCTIONS

This documentation provides the JE service partner with all the necessary technical information, describes the correct installation in accordance with the regulations and provides the customer with the necessary information for safe operation of the heater.

SPARE PARTS LIST

The spare parts list provides the JE service partner with the necessary information for ordering spare parts in case of repairs.

1 INTRODUCTION

SAFETY INSTRUCTIONS FOR INSTALLATION AND REPAIR



DANGER!

Improper installation or repair of Eberspächer heaters can cause a fire or result toxic exhaust entering the inside of the vehicle.

This can cause serious and even fatal risks.

- The heater may only be installed according to the specifications in the technical documents or repaired using original spare parts by authorised and trained persons.
- Installation and repairs by unauthorised and untrained persons, repairs using non-original spare parts and without the technical documents required for installation and repair are dangerous and therefore are not permitted.
- A repair may only be carried out in connection with the respective unit-related technical description, installation instructions, operating instructions and maintenance instructions.
This document must be carefully read through before / during installation and repair and followed throughout. Particular attention is to be paid to the official regulations, the safety instructions and the general information.

PLEASE NOTE!

- The relevant rules of sound engineering practice and any information provided by the vehicle manufacturer are to be observed during the installation and repair.
- When carrying out electric welding on the vehicle, the positive cable at the battery should be disconnected and placed at ground to protect the control box.

LIABILITY CLAIM / WARRANTY

Eberspächer does not accept any liability for defects and damage, which are due to installation or repair by unauthorised and untrained persons.

Compliance with the official regulations and the safety instructions is prerequisite for liability claims.

Failure to comply with the official regulations and safety instructions leads to exclusion of any liability of the heater manufacturer.

ACCIDENT PREVENTION

General accident prevention regulations and the corresponding workshop and operating safety instructions are to be observed.

INITIAL START-UP OF THE HEATER OR FUNCTIONAL TEST AFTER A REPAIR

- After installing or carrying out a repair on the heater, the whole fuel supply system must be carefully vented.
- Comply with the instructions issued by the vehicle manufacturer.
- During the heater trial run, all fuel connections must be checked for leaks and secure, tight fit.
- If faults occur while the heater is running, use a diagnostic unit to correct the cause of the fault.

EMERGENCY SHUTDOWN – EMERGENCY OFF

If an emergency shutdown – EMERGENCY OFF – is necessary during operation, proceed as follows:

- Switch the heater off at the control unit or
- remove the fuse or
- disconnect the heater from the battery.

2 FUNCTION AND OPERATION

CUTAWAY VIEW

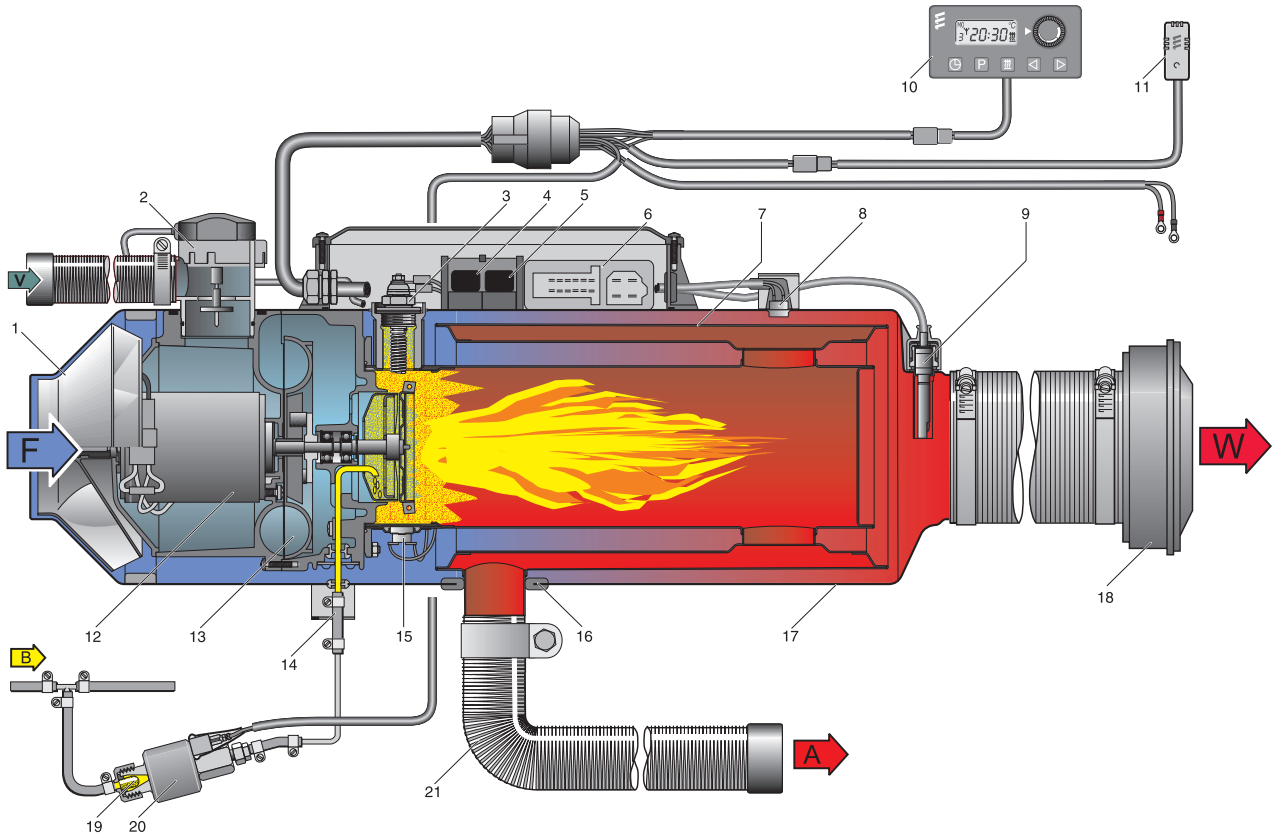

- | | |
|--------------------------------------|--|
| 1 Heater impeller | 15 Flame sensor |
| 2 Combustion air solenoid valve | 16 Exhaust pipe seal |
| 3 Glow plug | 17 Outer jacket |
| 4 Relay, control | 18 Outflow |
| 5 Glow plug relay | 19 Pot-type strainer, installed in the metering pump |
| 6 Control box | 20 Metering pump |
| 7 Heat exchanger | 21 Exhaust pipe |
| 8 Overheating switch | |
| 9 Temperature limiter | A = Exhaust |
| 10 Module timer | B = Fuel |
| 11 Room temperature sensor, external | F = Fresh air |
| 12 Fan motor | V = Combustion air |
| 13 Combustion air impeller | W = Hot air |
| 14 Fuel connection | |

2 FUNCTION AND OPERATION

FUNCTIONAL DESCRIPTION

SWITCHING ON

When the heater is switched on the operating display in the control unit lights up.

The glow plug is switched on and the fan starts at maximum speed. A clock relay ensures that the voltage at the glow plug does not exceed the allowable range.

STARTING THE HEATER

After approx. 25 sec. the metering pump starts pumping the fuel for the "HIGH" control stage.

After a stable flame has formed and the flame sensor has detected the flame, the glow plug is switched off after approx. 10 sec.

The heater continues running, positively controlled, for at least 30 sec. in "HIGH" control stage. Only then can the heat flow be controlled.

CONTROL IN HEATING MODE

During heating mode the interior temperature is measured constantly. If the heated air outlet temperature is higher than the temperature set at the control unit, the control starts.

Control stages "HIGH" and "LOW" are provided, so that it is possible to adjust the heat flow supplied by the heater to the heat requirement. If the set temperature is still exceeded in "LOW" control stage, the heater switches to the "OFF" control stage.

The fan runs on for approx. 3 minutes to cool down.

If the room temperature falls below the set value at the control unit, the heater restarts in the "HIGH" control stage

TEMPERATURE SELECTION WITH THE CONTROL UNIT

Use the rotary control knob to select the required interior temperature. The temperature setting can be between +10 °C and +30 °C, depending on the size of the space being heated and the prevailing outside temperature.

The required setting of the control knob is an empirical value.

VENTILATOR MODE

In ventilator mode the heater's fan runs in the "HIGH" setting.

SWITCHING OFF

When the heater is switched off the operating display in the control unit goes out.

The fuel pumping is switched off.

The fan runs on for approx. 3 minutes to cool down.

CONTROL AND SAFETY DEVICES

- The flame is monitored by the flame sensor, the maximum allowable temperature is monitored by the overheating switch. Both affect the control box, which switches off the heater in the event of faults.
- If the heater does not ignite within 90 seconds after the fuel starts to pump, the start is repeated.
- If the heater still does not ignite after another 90 seconds of pumping fuel, a safety lock-out occurs, i.e. the fuel supply is off and the fan continues to run for approx. 3 minutes. After an impermissible number of failed start attempts, the control box is locked.*
- If the flame goes off by itself during operation, the heater is restarted first.
- If the heater does not ignite within 90 seconds after the fuel delivery has restarted, or ignites and goes out again within 10 minutes, a safety lock-out occurs, i.e. the fuel delivery is switched off and the fan carries on running for approx. 3 minutes.
The shutdown on faults can be cancelled by briefly switching off and on again.
- In the case of overheating, the overheating sensor triggers, the fuel feed is interrupted and a shutdown on faults occurs.
If overheating is the cause of a shutdown on faults, the green operating display in the control unit flashes uniformly or the fault code is displayed in the control unit.
After the cause of the overheating has been eliminated, the heater can be restarted by switching it off and on again. After an impermissible number of failed start attempts, the control box is locked.*
- If the lower or upper voltage limit is reached, the heater is automatically shut down.
- The heater does not start up if the glow plug is defective or if the electric lead to the metering pump is interrupted.
- On starting, the function of the blower motor is tested. If the blower motor does not start up, the heater switches to fault.
During operation, the blower motor is cyclically (4 min.) monitored. If the motor speed is below the allowable limit a shutdown on faults occurs.

PLEASE NOTE!

- Do not repeat the switching off / on routine more than twice.

2 FUNCTION AND OPERATION

* The lock can be cancelled and faults read out using the:

- Module timer
- EasyStart T timer
- TP5 radio remote control
- EasyStart R⁺ radio remote control

With other control units by connecting the:

- Diagnostic unit
- EDiTH Basic diagnostic tool

For details of connection and use see [from page 13](#), for fault description and correction information see [from page 19](#) in these Troubleshooting and Repair Instructions.

3 TECHNICAL DATA

AIR HEATER 8 L

Heater type		8 L			
Heater version		D 8 L C			
Heating medium		Air			
Control of the heat flow		High		Low	
Heat flow (W)		8000		3500	
Heater air flow rate without counterpressure (kg/h)		310			
Heater code		8			
Fuel		Diesel – standard commercially available (EN 590)			
Fuel consumption (l/h)		1.05		0.4	
Rated voltage (V)		12		24	
Electrical power consumption (W)	during operation	High 115	Low 115	High 115	Low 115
	while starting	330		380	
Operating range					
Lower voltage limit: An undervoltage protection installed in the control box switches off the heater if the lower voltage limit is reached.		approx. 10 volt		approx. 20 volt	
Upper voltage limit: An overvoltage protection installed in the control box switches off the heater if the upper voltage limit is reached.		approx. 14 volt		approx. 28 volt	
Hot air intake temperature		max. +60 °C			
Allowable ambient temperature	Heater	during operation –40 °C to +60 °C		without operation –40 °C to +70 °C	
	Control box	–40 °C to +60 °C		–40 °C to +70 °C	
	Metering pump	–40 °C to +60 °C		–40 °C to +60 °C	
Interference suppression class		Far (further measures possible)			
Weight		approx. 14 kg			
Ventilation mode		possible with corresponding circuit			
Noise emission – passenger compartment		The maximum noise pressure level is <60 dB (A), measured in the operating mode power stage “High”, as per 3. GSGV and DIN 45 635 – part 1 respectively.			



ATTENTION!

Operating the heater outside the specified technical data can cause malfunctions.

→ The technical data must be complied with at all times.



PLEASE NOTE!

If no limit values are given, the technical data listed is with the usual heater tolerances of ± 10 % at nominal voltage and Esslingen reference altitude.

3 TECHNICAL DATA

CONTROL VALUES

Speed of the blower motor (at rated voltage)

- High 3400 1/min. +300 1/min.
- Low 3200 1/min. +300 1/min.
- After-run 3400 1/min. +300 1/min.

Solenoid valve	approx. 100 Ω at approx. 25 °C
Metering pump	12 V = 6 Ω / 24 V = 20 Ω
Glow plug	approx. 1 Ω
Control unit 12 V / 24 V	1740 Ω \pm 20 Ω to 2156 Ω \pm 60 Ω
Overheating switch	Switching values 70 °C and 90 °C
External room temperature sensor	1895 Ω to 1950 Ω at 20 °C

TEMPERATURE SENSOR DIAGRAM

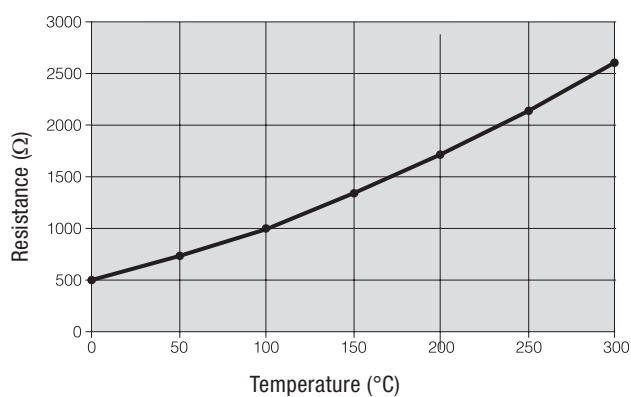

FLAME SENSOR DIAGRAM

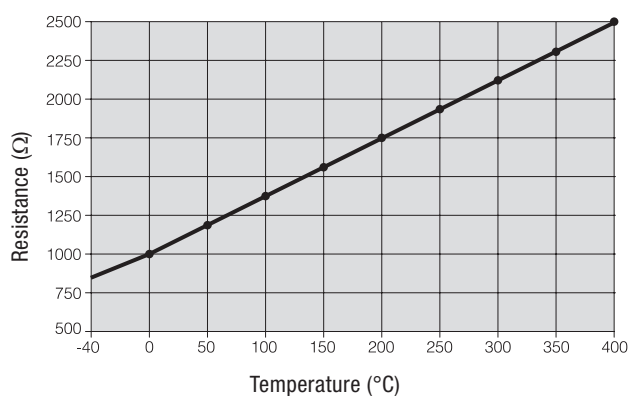

4 TROUBLESHOOTING

WHAT TO CHECK FIRST IN CASE OF FAULTS

CHECK

- Fuel in the tank?
- Fuel lines leaking? (visual check)
- Summer diesel still in the fuel lines?
- Hot air system blocked?
- In case of sooty combustion, check the following
 - Is the combustion air system or exhaust system blocked?
 - ⇒ Remove blockage.
 - Metering pump pumping too much?
 - ⇒ Measure fuel quantity ([see page 34](#)), if applicable, replace metering pump.

ELECTRICAL COMPONENTS

- Cables, connections damaged?
- Contacts corroded?
- Fuses defective?
- Incorrect wiring? (short circuit, interruption)

CHECK BATTERY VOLTAGE

Battery voltage < 10 V / < 20 V, the undervoltage protection has triggered.

CHECK VOLTAGE SUPPLY (TERMINAL 30)

Measure the applied voltage in connector A (circuit diagram [see page 36](#)) between chamber 3 (cable 2.5² rt) and chamber 4 (cable 1² br).

If it differs from the battery voltage, check the fuses, the supply cables, the ground connection and the positive support point on the battery for voltage drop (corrosion / interruption).

CHECK SWITCH-ON SIGNAL

Switch on the heater at the control unit. Check the control box to see whether a voltage is applied to connector B between chamber 9 (cable 1.5² ge) and connector A, chamber 4 (cable 1² br). If no voltage is applied, then test the supply cable (cable 1.5² ge) and the control unit.

USE THE CONTROL UNIT TO CALL THE DIAGNOSTIC SIGNALS

At the rear of the control box terminal 6 (ge) and terminal 4 (swws) or directly at the control unit, jumper connector B, chamber 9 (cable ge) and chamber 11 (cable swws) for 0.5 to 5 seconds.

SWITCH ON THE HEATER

The operating display lights indicate a diagnostic signal.

Diagnostic signal	Fault code	Fault
	000	No fault
	001 002	Early warning: Overvoltage / undervoltage
	010	Overvoltage cutout
	011	Undervoltage cutout
	020	Glow plug – interruption
	033 036	Burner motor is defective, Relay short circuit Air solenoid valve
	052	No start, Safety limit exceeded
	012	Overheating Metering pump interruption
	047	Short circuit in metering pump
	060-063	Temperature sensor: Interruption, short circuit Setpoint potentiometer: Interruption, short circuit
	064, 065	Flame sensor: Interruption, short circuit
	056	Flame cutout in low stage
	054	Flame cutout in high stage
	092	Control box defective
	091	Fault due to external interfer- ence voltage (reset)
	024	Glow plug relay short circuit

4 TROUBLESHOOTING

OVERVIEW OF THE TEST EQUIPMENT AND CONTROL UNITS

The electronic control box can store up to 5 faults, which can be read out and displayed.

The following test equipment / control units can be used to query the fault memory in the control box and if necessary to delete the locking of the control box:

Test equipment	Order No.
▪ Diagnostic unit	22 1529 89 00 00
▪ EDiTH Basic diagnostic tool	22 1524 89 00 00

The current software can be downloaded from the service portal.

Control unit	Order No.
▪ Module timer	22 1000 30 38 00
▪ TP5 radio remote control	22 1000 32 01 00
▪ EasyStart T	22 1000 32 88 00
▪ EasyStart R+	22 1000 32 80 00

PLEASE NOTE!

- The diagnostics cable (cable 0.5² bl/ws) must also be connected if using control units.
If the fault memory cannot be read out, check the diagnostics cable is properly laid and is not damaged.
-

EXTERNAL DIAGNOSTICS SYSTEM

If an external, vehicle-specific diagnostics system is used ⇒ please consult the vehicle manufacturer.

4 TROUBLESHOOTING

FAULT DIAGNOSIS USING THE DIAGNOSTIC UNIT

(Order No.: 22 1529 89 00 00)

The current fault is displayed as "AF" and a 2-digit number and is always written in memory location F1.

The stored faults "F1" to "F5" can be displayed.

PLEASE NOTE!

- It is very important to always install in the given order.
- Not only the defective component, but also a defective current path results in a display.
- Fault code, fault description, cause / remedial action are described [from page 19](#).

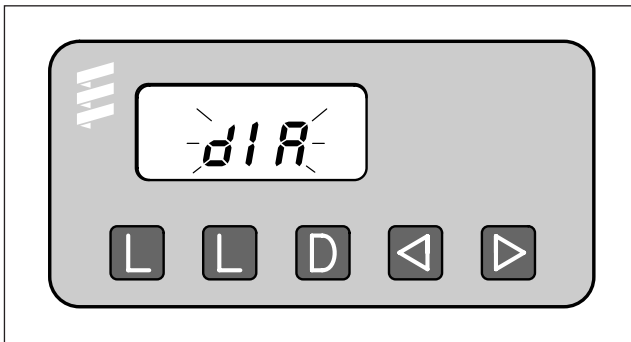

- Delete fault memory
- Delete fault memory
- Switch heater on / off, request diagnosis
- Return, F5 – F1
- Flow, F1 – F5, current fault (AF)

DIAGNOSTIC UNIT CONNECTION AT THE CONTROL BOX

(see following sketch)

To connect the diagnostic unit to the control box you must lay your own adapter cable.

- Lay and connect a cable from the diagnostic unit (6 pin connector housing, chamber 3) to the control box (14 pin connector B, chamber 4, cable 1.5² blws).
- Lay and connect a cable from the diagnostic unit (6 pin connector housing, chamber 5) to the control box (4 pin connector A, chamber 3, cable 2.5² rt).
- Lay and connect a cable from the diagnostic unit (6 pin connector housing, chamber 1) to the control box (4 pin connector A, chamber 4, cable 1.5² br).
- Connect the 6 pin connector housing of the adapter cable to the 6 pin tab connector housing of the diagnostic unit.

Display

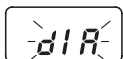

CONNECT THE ADAPTER CABLE TO THE DIAGNOSTIC UNIT AND THE CONTROL BOX

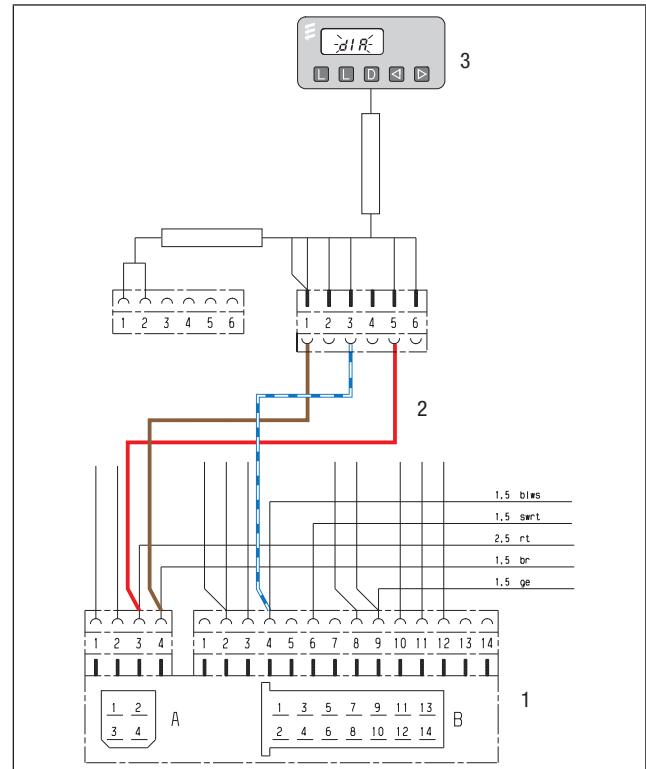

PLEASE NOTE!

The complete circuit diagram of the heater [see page 36](#).

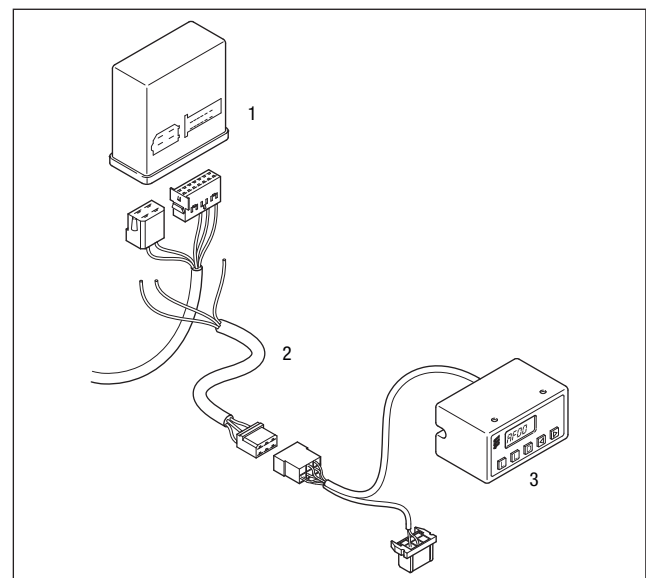

- Control box
- Adapter cable (laid by user)
- Diagnostic unit

4 TROUBLESHOOTING

QUERY THE FAULT MEMORY

- Use the  button to switch on the heater.

Display is as follows:

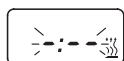

Heater has no malfunction

- The following is displayed after 8 sec:

Display is as follows:



Heater has no malfunction

or



e.g. current fault / fault code 64

or





Fault diagnosis not possible

Possible causes

- Adapter cable is not properly connected.
- Control box is defective or is not capable of diagnosing (not a universal control box).

DISPLAY OF THE FAULT MEMORY F1 – F5 OR F5 – F1

- Press the  or  button again, or press several times, to display the fault memory.

Display is as follows:

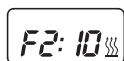

e.g. fault memory 2 / fault code 10

PLEASE NOTE!

Only the fault memory locations with an error assigned to them are displayed.

DELETE FAULT MEMORY

- Press both  buttons simultaneously until the following appears in the display:

Display is as follows:

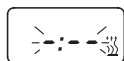

- If the fault memory has been deleted the most recent current fault is displayed. The current fault is not reset to 00 until the heater is restarted – provided no new fault exists.

Display is as follows:

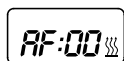

Heater has no malfunction

CANCEL THE CONTROL BOX LOCK

- Delete the fault memory as described and use the  button to switch off the heater.

- The control box lock is cancelled and the diagnosis closed.

Display is as follows:

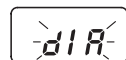

4 TROUBLESHOOTING

FAULT DIAGNOSIS WITH THE EDITH BASIC DIAGNOSTIC TOOL

Order no. 22 1541 89 00 00

PLEASE NOTE!

- Always connect in the given order!
- To read out the faults and to connect the EDiTH Basic to the control box you must lay your own adapter cable.
- The 14 pin plug-in connection may not be disconnected until the heater has been switched off and the after-running has finished.
- The EDiTH Basic can only be used to read out the faults stored in the control box and the current faults.
- Note and follow the EDiTH Basic operating instructions.
- Fault code, fault description, cause / remedial action are described [from page 19](#).

EDITH BASIC CONNECTION AT THE CONTROL BOX

To connect the EDiTH Basic to the control box you must lay your own adapter cable.

1. Lay and connect a cable from the EDiTH Basic (6 pin connector housing, chamber 3) to the control box (14 pin connector B, chamber 4, cable 1.5² blws).
2. Lay and connect a cable from the EDiTH Basic (6 pin connector housing, chamber 5) to the control box (4 pin connector A, chamber 3, cable 2.5² rt).
3. Lay and connect a cable from the EDiTH Basic (6 pin connector housing, chamber 1) to the control box (4 pin connector A, chamber 4, cable 1.5² br).
4. Connect the 6 pin connector housing of the adapter cable to the 6 pin tab connector housing of the EDiTH Basic.
5. Connect the SUB-D connection cable to the EDiTH Basic and to the PC.

CONNECT THE ADAPTER CABLE TO THE EDITH BASIC DIAGNOSTIC TOOL AND TO THE CONTROL BOX

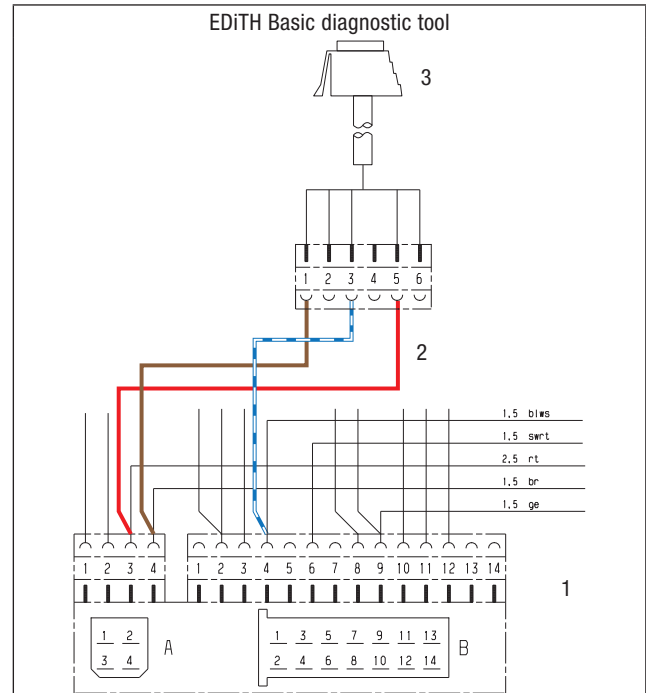

PLEASE NOTE!

The complete circuit diagram of the heater [see page 36](#)

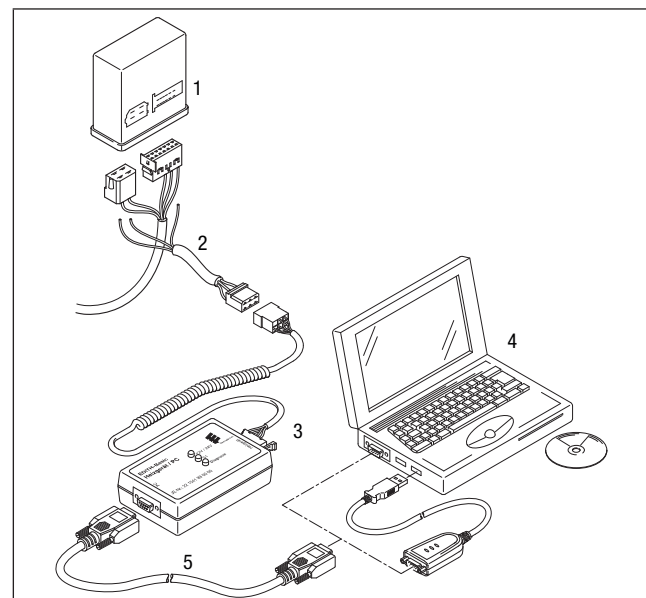

- 1 Control box
- 2 Adapter cable (laid by user)
- 3 Connection to the EDiTH Basic diagnostic tool
- 4 PC
- 5 Sub-D connection cable

4 TROUBLESHOOTING

FAULT DIAGNOSIS USING THE MODULE TIMER

Order No. 22 1000 30 38 00

The current fault is displayed as "AF" and a 2-digit number and is always written in memory location F1. Previous faults are transferred into memory location F2 to F5. The stored faults "F1" to "F5" can be displayed.

PLEASE NOTE!

- Only the fault memory locations with an error assigned to them are displayed.
- The bl/ws diagnostic cable must be connected in order to perform the diagnosis. Note and follow the heater's circuit diagram.
- Ensure adequate battery voltage (min. 10.5 V).
- Not only the defective component, but also a defective current path results in a display.
- Fault code, fault description, cause / remedial action are described [from page 19](#).

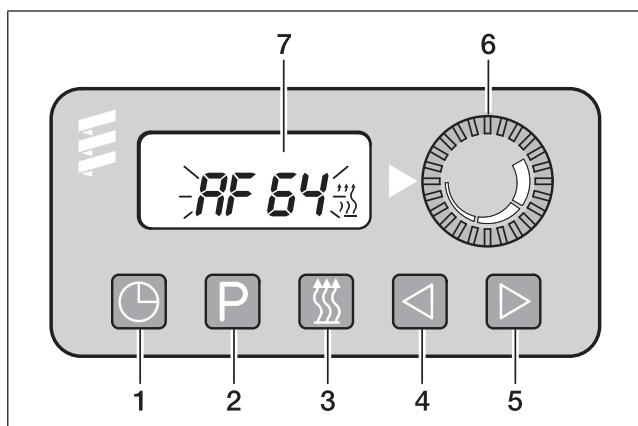

- 1 [Clock] button – time
- 2 [P] button – preselection
- 3 [Heater] button – heat
- 4 [Left Arrow] button – return
- 5 [Right Arrow] button – flow
- 6 Temperature controller
- 7 Display with "Current fault"

DISPLAY CURRENT FAULT

Condition: The heater is switched off.

- Press [Heater] button ⇨ heater is switched on.
- Press [Clock] button and keep it pressed, then press [P] button within 2 seconds.

Display is as follows:

Current fault (e.g. fault code 64)



DISPLAY FAULT MEMORY F1 – F5

The individual fault memory locations are displayed in ascending order by pressing or repeatedly pressing button [Right Arrow].

Display is as follows:

e.g. fault memory 2 / fault code 10

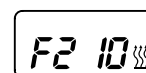

CANCEL THE CONTROL BOX LOCK AND SIMULTANEOUSLY DELETE THE FAULT MEMORY

Condition:

An electrical connection exists from terminal 15 (ignition) to the module timer, 12-pin connector, chamber 10.

- Press [Heater] button

Display is as follows:

the current fault F15 or F50.

- Press button [Clock], keep it pressed and press button [P] within 2 seconds.

The module timer is now in the "Enquire fault memory" program.

- Switch off ignition (terminal 15).
- Press button [Clock] and button [P] at the same time, in addition, switch on the ignition (terminal 15) and wait until the following appears in the display.

After ignition "ON" the following appears in the display:

Display flashes

Heater symbol does not flash

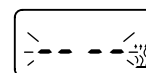

- Switch the heater off and on ⇨, the control box is unlocked and the heater restarts.

After switching the heater off and on and re-enquiring the fault memory the following appears in the display:

Display flashes,

Heater symbol does not flash



4 TROUBLESHOOTING

FAULT DIAGNOSIS USING THE RADIO REMOTE CONTROL TP5





Order No. 22 1000 32 01 00

If faults occur while the heater is running, they are displayed with "Err" after the mobile unit is activated.

PLEASE NOTE!

- Before the diagnosis can be performed the diagnostic cable (blue / white) must be connected. To this end, please refer to and follow the circuit diagram for the radio remote control or the timer and for the heater.
- If the diagnostic cable (blue / white) is not connected, the "Diagnosis" menu is blocked.
- Ensure adequate battery voltage (min. 10.5 V / min. 21 V).
- Not only the defective component, but also a defective current path results in a display.
- Fault code, fault description, cause / remedial action are described [from page 19](#).



-  button for activating / deactivating the mobile unit
-  button for forward time setting
-  button for backward time setting
-  button for activating the setting options
-  button for switching heat / ventilate ON / OF;
activate / deactivate preselection time

After the diagnostic cable (blue / white) has been connected and the first logs have arrived at the stationary unit, the diagnose can be carried out using the mobile unit of the TP5 radio remote control. The current fault is displayed, e.g. "F064". The stored faults "F1" to "F5" can be displayed.

Example:

- "F0 --" = undisturbed operation
- "F064" = current fault 64
- "F210" = Fault 10 stored in fault memory position 2 ("F2").

DISPLAY CURRENT FAULT OR DISPLAY / DELETE FAULT MEMORY

Use the  button to activate the mobile unit.

Switch on the heater with the  button.

Press the  button twice to open the Time setting menu – the time flashes in the display.

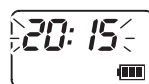

Press the  button for approx. 2 sec – until the following appears in the display:



Press the  button.

Press the  button.

Press the  button twice.

Press the  button.

Display

Current fault



Display

No errors/faults exist

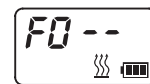



Use the  and  buttons to display the fault memory locations 1 to 5.



DELETE FAULT MEMORY AND CANCEL THE CONTROL BOX LOCK

Use the  button to delete the fault memory.



To confirm, press the  button for approx. 2 sec until  lights up in the display – fault memory is deleted.



PLEASE NOTE!

If the fault memory is to be deleted later, the whole procedure must be repeated.

4 TROUBLESHOOTING

FAULT DIAGNOSIS WITH EASYSTART R+ AND EASYSTART T

- EasyStart R+ radio remote control (Order No.: 22 1000 32 80 00)
- EasyStart T timer (Order No.: 22 1000 32 88 00)

If faults occur in the heater while it is running, they are displayed with "Err" after the mobile unit or timer has been activated.

The current fault and the stored faults "F1" to "F5" can be displayed.

PLEASE NOTE!

- The bl/ws diagnostic cable must be connected in order to perform the diagnosis. To this end, please refer to and follow the circuit diagram for the radio remote control or the timer and for the heater.
- If the diagnostics cable is not connected, the "Diagnosis" menu is blocked.
- Not only the defective component, but also a defective current path results in a display.
- Fault code, fault description, cause / remedial action are described [from page 19](#).
- Ensure adequate battery voltage (min. 10.5 V / min. 21 V).



 backwards control button

 forwards control button

 ON / OFF activation button

 OK button (symbol selection / input confirmation)

QUERY / DELETE FAULT MEMORY AND CANCEL THE HEATER LOCK

Activate mobile unit / timer

(see EasyStart R+ / EasyStart T operating instructions)

Confirm  symbol with .



SEND



SEND

The heater is switched on.

Confirm operating time with .

Following activation, the following can be shown in the display (display appears after approx. 20 sec.):

Display if errors/faults exist



Display if no errors/faults exist



The following actions are possible with both displays:

- Display current fault in fault memory.

Briefly press  and  at the same time.

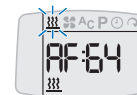

- Display fault memory F1 – F5.

Press  or .



The current fault is always written in fault memory F1.

- Display fault memory again.

Briefly press  and  at the same time.



- Delete the fault memory and as a result, at the same time cancel the control box lock.

Confirm current fault or one of the faults F1 – F5 with .

Confirm display dEL again with .



The fault memory is deleted and the control box is unlocked.

- Switch off the heater.

Press .



4 TROUBLESHOOTING

Fault code	Fault description	Comments
000	No fault	— —
001	Early warning, overvoltage	Voltage at the control box, connector housing A between Pin 3 and Pin 4 is >14 V / >28 V.
002	Early warning, undervoltage	Voltage at the control box, connector housing A between Pin 3 and Pin 4 is <10 V / <20 V.
010	Overvoltage shutdown	Heater not functioning. Overvoltage applied to control box for at least 20 seconds without interruption. <ul style="list-style-type: none"> ▪ Start the vehicle engine, measure the voltage at the control box, connector housing A between Pin 3 and Pin 4. If the voltage is >14 volt / >28 volt, then check the battery, the alternator controller and the electric cables.
011	Shutdown due to undervoltage (heater not functioning)	Heater not functioning. Undervoltage applied to control box for at least 20 seconds without interruption. <ul style="list-style-type: none"> ▪ With the vehicle engine switched off, measure the voltage at the control box, connector housing A between Pin 3 and Pin 4. If the voltage is <10 volt / <20 volt, then check the fuses, the electric cables, the earth connections and the positive support point at the battery for voltage drop (corrosion).
012	Overheating or metering pump interruption	Metering pump is not functioning or temperature at the overheating sensor is >90 °C. <ul style="list-style-type: none"> ▪ Check hot air system for blockage, if necessary remove blockage. ▪ Check electric cables from control box, connector housing A, Pin 2 and connector housing B, Pin12 for continuity, correct laying and damage. ▪ Check the metering pump, renew if necessary – control values see page 34. ▪ Check the overheating sensor, renew if necessary – control values see page 10.
020	Glow plug interruption	<ul style="list-style-type: none"> ▪ Check the glow plug, renew if necessary – control values from page 10.
023	Glow plug relay,	Check electric cable from control box, connector housing B, Pin 5 to the glow plug relay, Pin 85 for continuity, correct laying and damage. – If ok, renew glow plug relay.
024	Coil – interruption	
	Glow plug relay, Coil – short circuit	
025	Diagnosis output short circuit	A plus signal is applied at the control box, connector housing B, Pin 4 (connection must be potential-free). <ul style="list-style-type: none"> ▪ Check the cable from the control box, connector housing B, Pin 4 to the control unit (diagnostic display), if necessary correct fault
033	Burner motor does not rotate (Control) relay is defective	Impeller or combustion air fan motor is blocked (frozen, dirty, sluggish). <ul style="list-style-type: none"> ▪ Remove blockage. ▪ Check the cable from the relay (2.5.5, control), Pin 87 for continuity, correct laying and damage. ▪ Check the (control) relay, renew if necessary.
036	(Control) relay – short circuit	<ul style="list-style-type: none"> ▪ Check electric cable from the control box, connector housing B, Pin 6 to the relay (2.5.5, control), Pin 85 for continuity, correct laying and damage. ▪ Check the (control) relay, renew if necessary.
047	Short circuit in metering pump	<ul style="list-style-type: none"> ▪ Check connection of control box B12 up to the metering pump for short circuit. ▪ Check metering pump, replace if necessary.

4 TROUBLESHOOTING

Fault code	Fault description	Comments ▪ Remedial action
052	No start – safety time limit exceeded	No flame detected within the start phase. <ul style="list-style-type: none"> ▪ Check exhaust and combustion air system. ▪ Check the fuel quantity and fuel supply, see page 34. ▪ Strainer inserted in the connection socket of the metering pump is dirty, --> renew strainer. ▪ Check the glow plug, renew if necessary – control values see page 10. ▪ Check the flame sensor, renew if necessary – control values see page 10.
054 056	Flame cutout in “High” control stage Flame cutout in “Low” control stage	The heater has ignited and detected the flame, a flame cutout then occurs. <ul style="list-style-type: none"> ▪ Check exhaust and combustion air system. ▪ Check the fuel quantity and fuel supply, see page 34. ▪ Strainer inserted in the connection socket of the metering pump is dirty, ⇨ renew strainer. ▪ Check the flame sensor, renew if necessary – control values see page 10. ▪ Check the fan speed, renew fan if necessary – control values see page 10. ▪ Check the function of the solenoid valve, renew if necessary.
060 061	Temperature sensor – interruption Temperature sensor – short circuit	Temperature sensor signals temperature value outside the measuring range. <ul style="list-style-type: none"> ▪ Check the cables from the temperature sensor to the printed circuit board for continuity, correct laying and damage. ▪ Check the temperature sensor, renew if necessary – control values see page 10.
062 063	Setpoint potentiometer – interruption Setpoint potentiometer – short circuit	Potentiometer of the control unit signals setpoint outside of the control range. <ul style="list-style-type: none"> ▪ Check the cables from the control box, connector housing A and B and from the control unit up to the 14 pin connector for continuity, correct laying and damage. ▪ Check the control unit, renew if necessary – control values see page 10.
064 065	Flame sensor interruption Flame sensor – short circuit	Flame sensor signals temperature value outside the measurement range. <ul style="list-style-type: none"> ▪ Check the electric cables from the control box, connector housing B, Pin 2 and Pin 10 up to the flame sensor for continuity, correct laying and damage ▪ Check the flame sensor, renew if necessary – control values see page 10.
091	Fault due to external interference voltage (reset)	Control box fault due to interference voltages from the vehicle's electrical system. Possible causes: Battery defect, charger defect, other fault sources. <ul style="list-style-type: none"> ▪ Remove interference voltages.
092	Control box defective	<ul style="list-style-type: none"> ▪ Replace control box.

5 REPAIR INSTRUCTIONS

REPAIR WORK

The permitted repair work to the heater is described in the "Repair Instructions" chapter. The heater must be removed from the vehicle for the repair work to be carried out.

The heater is assembled in the reverse order, note and follow any additional instructions.

PLEASE NOTE!

After completing all the work and installing the heater in the vehicle, perform a functional check on the heater.

SAFETY INSTRUCTIONS TO BE NOTED AND FOLLOWED BEFORE WORKING ON THE HEATER

DANGER!

RISK OF INJURY, BURNS AND POISONING!

- Always switch off the heater beforehand and leave it to cool.
- Disconnect the battery.
- The heater must not be operated in closed rooms such as garages or workshops.
Exception:
Exhaust suction available directly at the entry to the exhaust pipe.

ATTENTION!

- The seals of dismantled components must be renewed.
- During repair work, check all components for damage and if necessary replace.
- Check connector contacts, plug-in connections and cables for corrosion and damage and if necessary repair.
- Only ever use Eberspächer spare parts if replacements are necessary.
- Operation or the after-running of the heater may only be stopped in an emergency ("EMERGENCY OFF" [see page 5](#)) by interrupting the battery current (risk of heater overheating).

PARTS LIST FOR ASSEMBLY DRAWING

- 1 Cover
- 2 Glow plug
- 3 Solenoid valve
- 4 Printed circuit board
- 5 Control box
- 6 Overheating switch
- 7 Temperature sensor
- 8 Flame sensor
- 9 Intake hood
- 10 Outlet hood
- 11 Jacket
- 12 Heat exchanger
- 13 Fan
- 14 Impeller
- 15 Lining and insulation
- 16 Relay, control
- 17 Relay, glow plug
- 18 Cable loom
- 19 Seal, fan / heat exchanger
- 20 Grommet, exhaust pipe
- 21 Grommet, fuel pipe
- 22 Grommet, flame sensor / overheating sensor cable loom
- 23 Fuse for impeller
- 24 Washer, A 4.3
- 25 Bolt, B 4.2x19
- 26 Spring lock washer, B 5
- 27 Hexagon nut, M 5

5 REPAIR INSTRUCTIONS

ASSEMBLY DRAWING

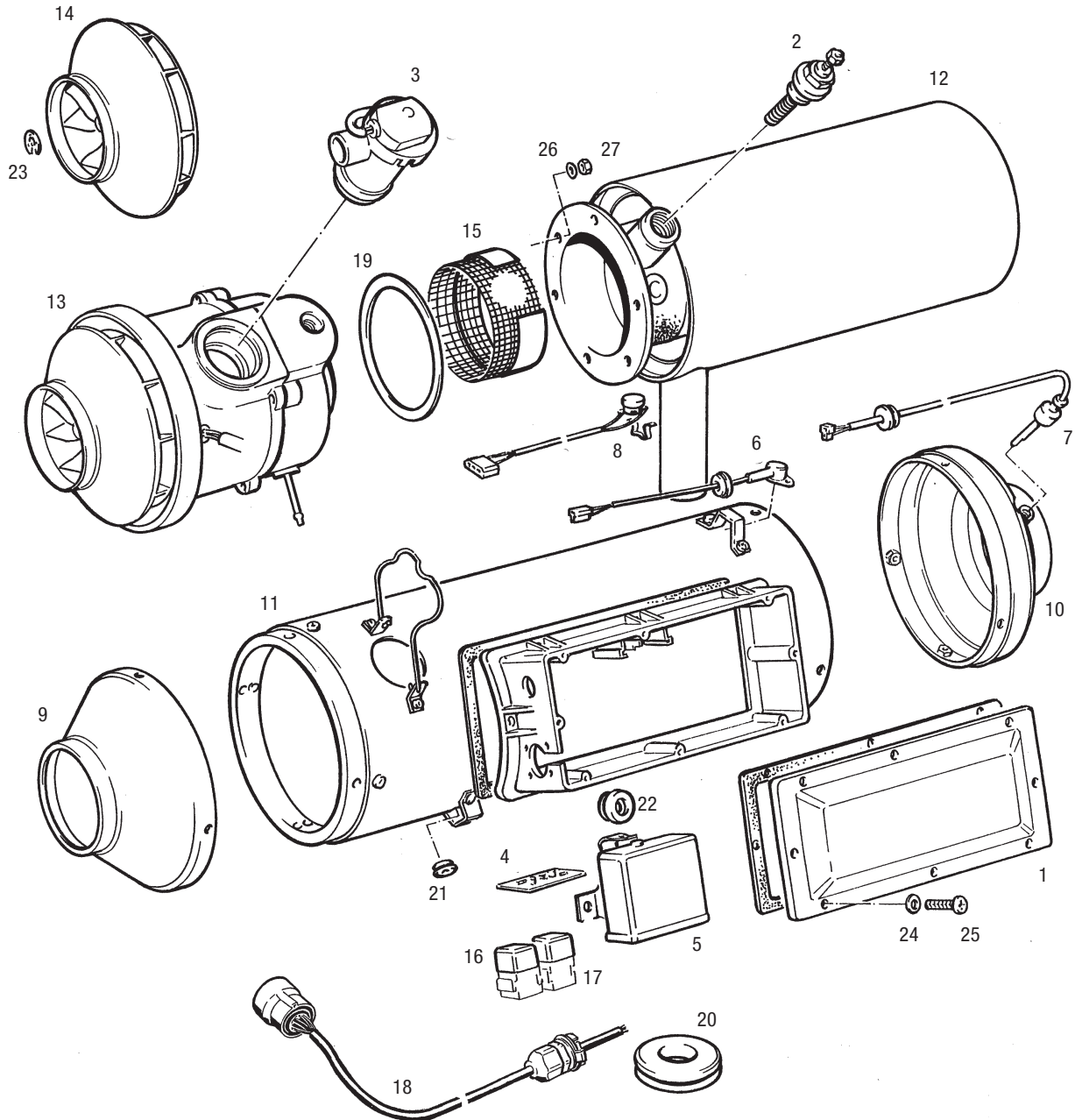

5 REPAIR INSTRUCTIONS

CONTENTS AND PAGE REFERENCES FOR REPAIR STEPS 1-15

PLEASE NOTE!

This repair instruction describes how to dismantle the heater in individual repair steps. Reference is made to the necessary preceding steps to be performed at the relevant repair steps.

Repair step 1 [Page 24](#)

Dismantle maintenance cover from safety housing

Repair step 2 [Page 24](#)

Dismantle glow plug and check its function

Test glow plug

Repair step 3 [Page 25](#)

Dismantle solenoid valve for combustion air

Repair step 4 [Page 26](#)

Dismantle printed circuit board

Repair step 5 [Page 26](#)

Dismantle control box

Repair step 6 [Page 27](#)

Dismantle overheating switch

Check overheating switch

Repair step 7 [Page 28](#)

Dismantle temperature sensor

Check temperature sensor

Repair step 8 [Page 29](#)

Dismantle glow plug relay and control relay

Repair step 9 [Page 29](#)

Dismantle safety housing with cable loom

Repair step 10 [Page 30](#)

Dismantle outer jacket, hood and brackets

Repair step 11 [Page 31](#)

Dismantle flame sensor

Check flame sensor

Repair step 12 [Page 31](#)

Dismantle inlet hood

Repair step 13 [Page 32](#)

Dismantle blower from heat exchanger

Repair step 14 [Page 32](#)

Dismantle impeller

Repair step 15 [Page 33](#)

Dismantle combustion chamber lining

VIEW OF COMPLETE UNIT



5 REPAIR INSTRUCTIONS

REPAIR STEPS 1 – 15

REPAIR STEP 1

DISMANTLE MAINTENANCE COVER FROM THE SAFETY HOUSING

- Unscrew the 8 fixing screws of the maintenance cover.
- Remove the maintenance cover.

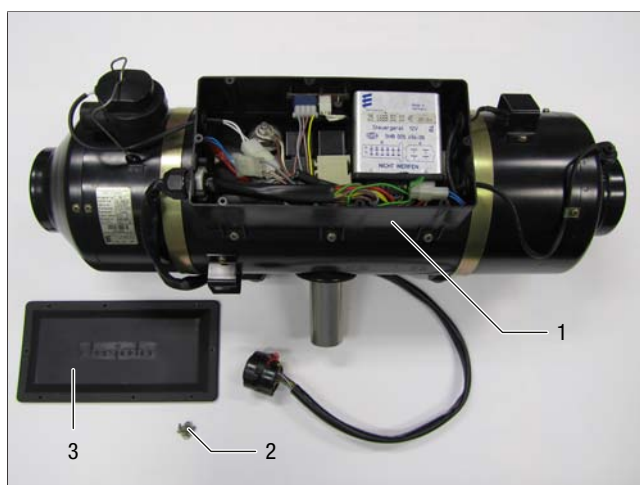

- 1 Safety housing
- 2 Fixing screws
- 3 Maintenance cover

PLEASE NOTE!

NOTES FOR THE ASSEMBLY:

Fixing screws tightening torque: 1.5^{+1} Nm

REPAIR STEP 2

DISMANTLE GLOW PLUG AND CHECK ITS FUNCTION

To dismantle the glow plug, complete [Repair step 1](#) first.

- Dismantle the spark plug connection from the glow plug.
- Use a ring spanner or another suitable tool to unscrew the glow plug.

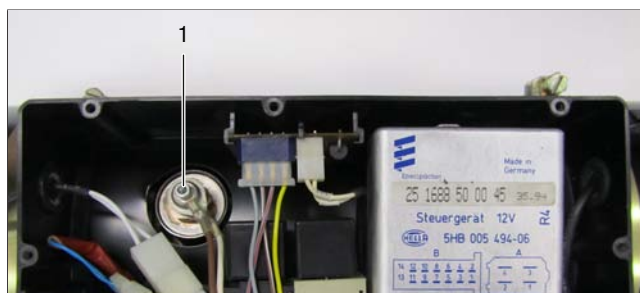

- 1 Spark plug connection with cable

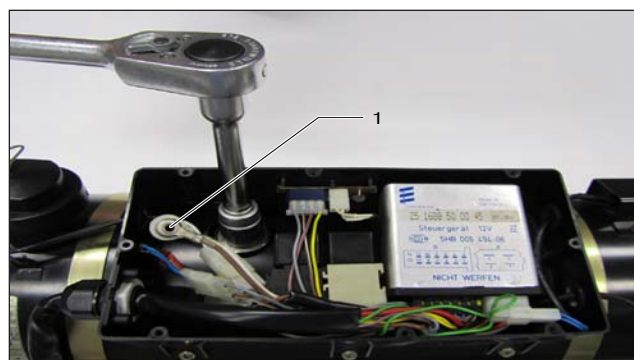
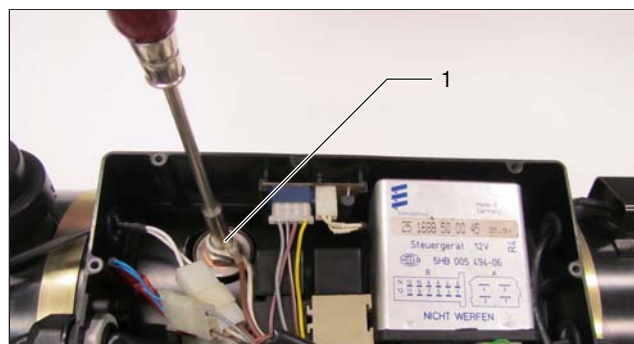

- 1 Spark plug connection with cable
- 2 Glow plug

TEST THE GLOW PLUG

Use a digital multimeter to test the glow plug.

Control values [see page 10](#).

PLEASE NOTE!

NOTES FOR THE ASSEMBLY:

Glow plug tightening torque: 17^{+2} Nm

5 REPAIR INSTRUCTIONS

REPAIR STEP 3

DISMANTLE SOLENOID VALVE FOR COMBUSTION AIR

To dismantle the solenoid valve for combustion air, complete [Repair step 1](#) first.

- Dismantle the combustion air hose from the solenoid valve.
- Disconnect the plug-in connection of the solenoid valve in the safety housing.
- Unpin both cables of the solenoid valve cable loom from the 2-pin connector housing.
- Unlock the solenoid valve with the clip.
- Pull the solenoid valve off the heater.
- Pull the lead harness through the grommet and out of the safety housing.

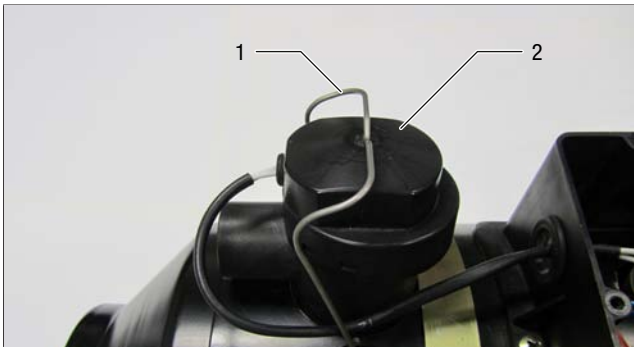

- 1 Clip
- 2 Solenoid valve

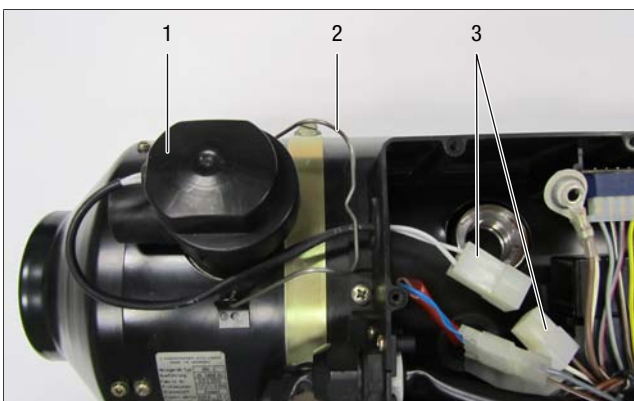

- 1 Solenoid valve, unlocked
- 2 Clip
- 3 Solenoid valve plug-in connection (disconnected)

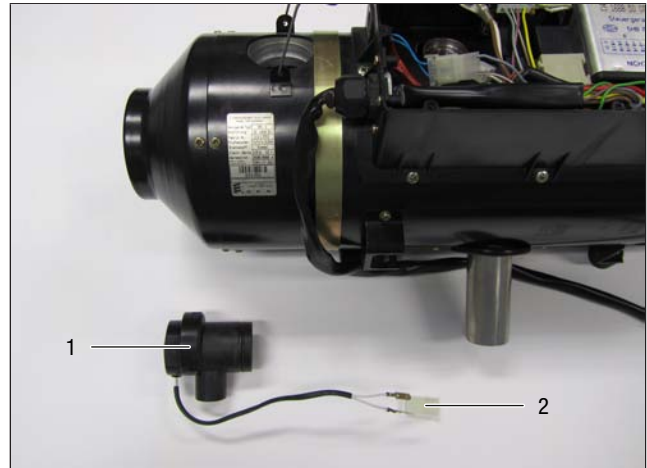

- 1 Solenoid valve
- 2 2 pin connector housing

5 REPAIR INSTRUCTIONS

REPAIR STEP 4

DISMANTLE PRINTED CIRCUIT BOARD

To dismantle the printed circuit board, complete [Repair step 1](#) first.

- Pull the 2 pin and 4 pin connector housing off the printed circuit board.
- Unlock the printed circuit board and pull it out of the guide.

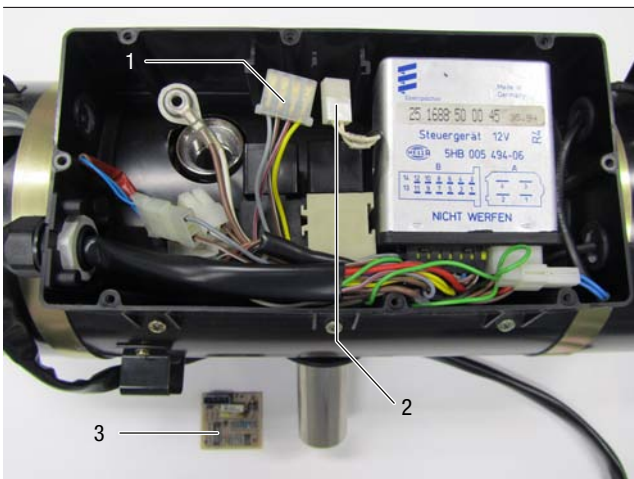
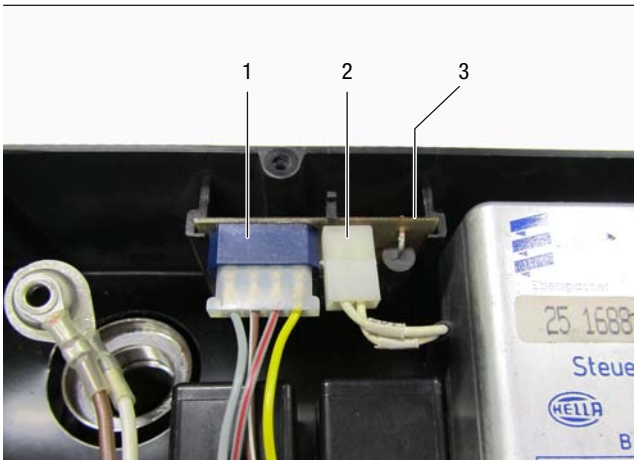

- 1 4 pin connector housing
- 2 2 pin connector housing
- 3 Printed circuit board

REPAIR STEP 5

DISMANTLE CONTROL BOX

To dismantle the control box, complete [Repair step 1](#) first.

- Unlock the control box and remove it from the bracket.
- Pull the 14 pin connector housing and 4 pin connector housing off the control box.

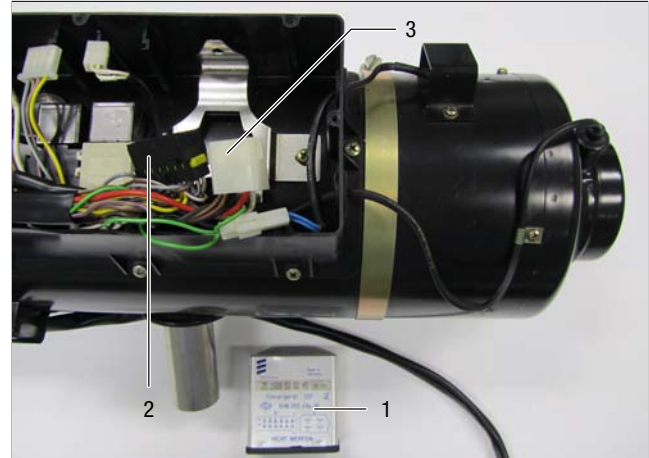

- 1 Control box
- 2 14 pin connector housing
- 3 4 pin connector housing

5 REPAIR INSTRUCTIONS

REPAIR STEP 6

DISMANTLE OVERHEATING SWITCH

To dismantle the overheating switch, complete [Repair step 1](#) first.

- Disconnect the 2 pin plug-in connection from the overheating switch in the safety housing.
- Undo two crosshead screws from the protective bracket of the overheating switch and remove the protective bracket.
- Undo two crosshead screws from the overheating switch and remove the overheating switch.

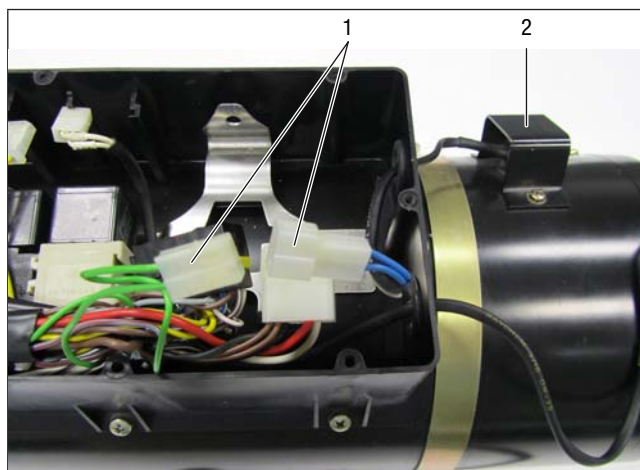
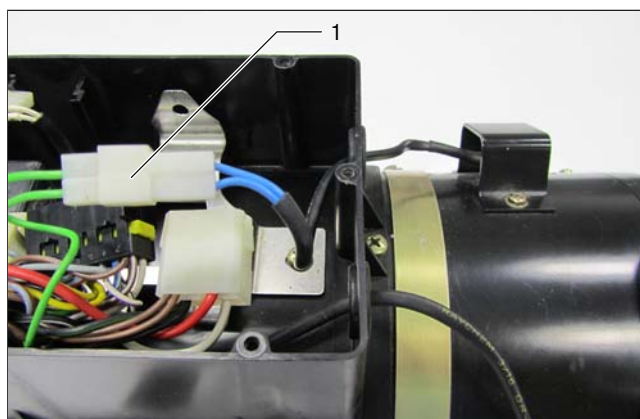

- 1 Plug-in connection of the overheating switch
- 2 Protective bracket, overheating switch

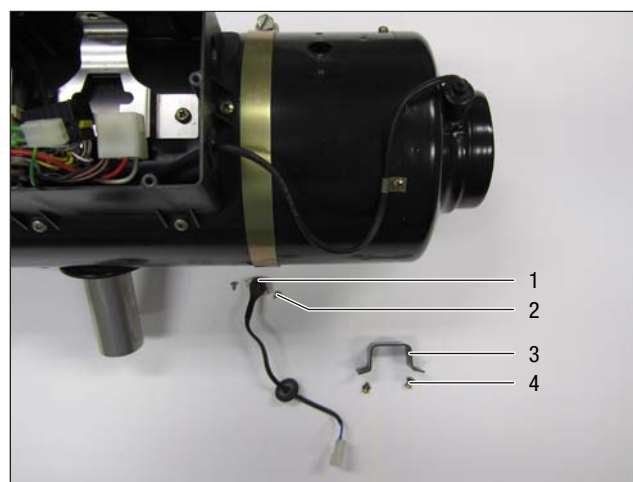

- 1 Overheating switch
- 2 Fixing screws (crosshead), overheating switch
- 3 Protective bracket, overheating switch
- 4 Fixing screws (crosshead), protective bracket

CHECK OVERHEATING SWITCH

Check the switching values of the overheating switch.

Control values [see page 10](#).

If the measured value differs, replace the overheating switch.

PLEASE NOTE!

NOTES FOR THE ASSEMBLY:

Tightening torque for fixing screws of the protective bracket and overheating switch: $1.4^{+0.5}$ Nm

5 REPAIR INSTRUCTIONS

REPAIR STEP 7

DISMANTLE TEMPERATURE SENSOR

To dismantle the temperature sensor, complete [Repair step 1](#) first.

- Unscrew the cable holder at the heater.
- In the safety housing, pull the 2 pin connector housing off the printed circuit board.
- Push back the protective cap at the temperature sensor and undo the union nut.
- Pull the lead harness together with the grommet out of the safety housing.
- Pull the temperature sensor out of the outlet hood.

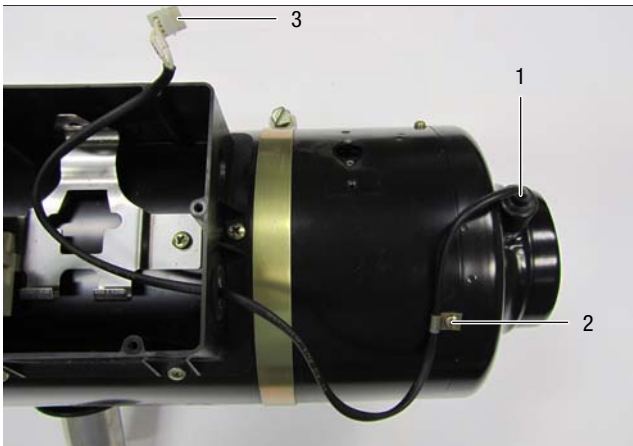

- 1 Temperature sensor
- 2 Cable holder
- 3 2 pin connector housing
- 4 Protective cap



- 1 Temperature sensor
- 2 Cable holder
- 3 2 pin connector housing
- 4 Protective cap
- 5 Grommet

CHECK TEMPERATURE SENSOR

Use a digital multimeter to test the temperature sensor.

Control values [see page 10](#).

If the measured value differs from the curve in the diagram, replace the temperature sensor.

PLEASE NOTE!

NOTES FOR THE ASSEMBLY:

Ensure the temperature sensor sits correctly in the guide groove.

Tightening torque for cable holder fixing screw: $1.4^{+0.5}$ Nm

5 REPAIR INSTRUCTIONS

REPAIR STEP 8

DISMANTLE THE GLOW PLUG RELAY AND CONTROL RELAY

To dismantle both relays, complete [Repair step 1](#) first.

- Pull the glow plug relay and the control relay off the pin base.

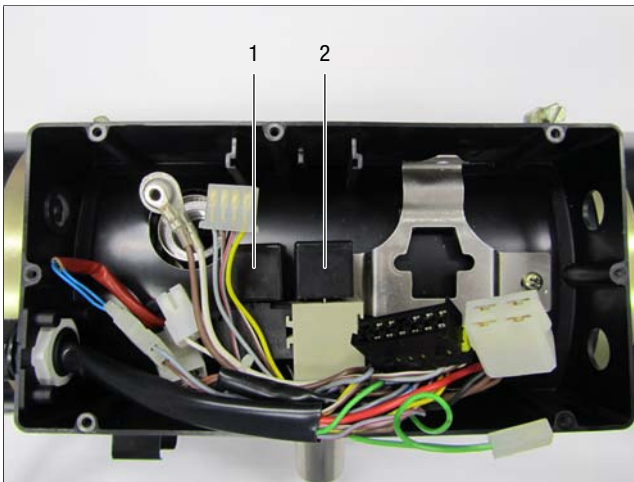

- 1 Control relay
- 2 Glow plug relay

REPAIR STEP 9

DISMANTLE SAFETY HOUSING WITH CABLE LOOM

To dismantle the safety housing with cable loom, complete [Repair step 1-8](#) first (pull cable looms off the components).

- Unscrew the fixing screw of the glow plug relay pin base and the control relay pin base.
- Disconnect the 3 pin plug-in connection from the flame sensor cable loom.
- Disconnect the 3 pin plug-in connection from the electric motor cable loom.
- Unscrew the 8 fixing screws of the safety housing.
- Remove the safety housing with the cable loom.

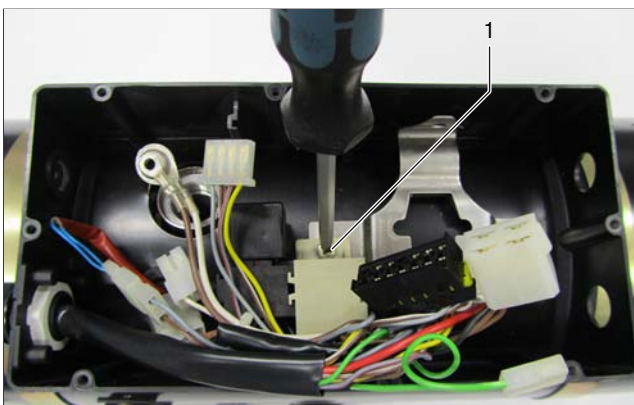

- 1 Unscrew the fixing screw of the glow plug relay pin base

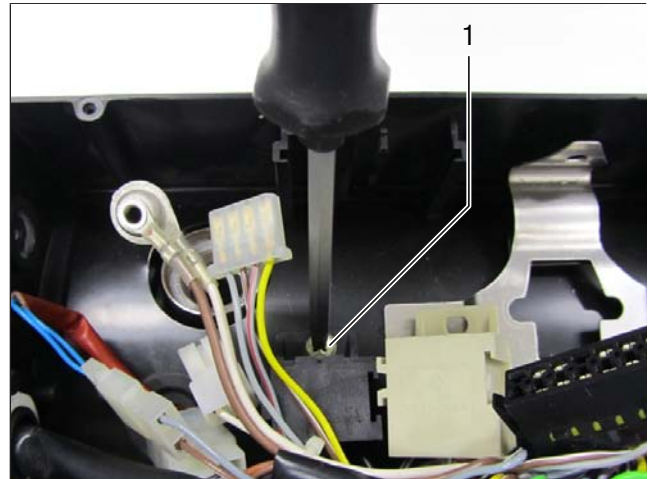

- 1 Unscrew the fixing screw of the control relay pin base

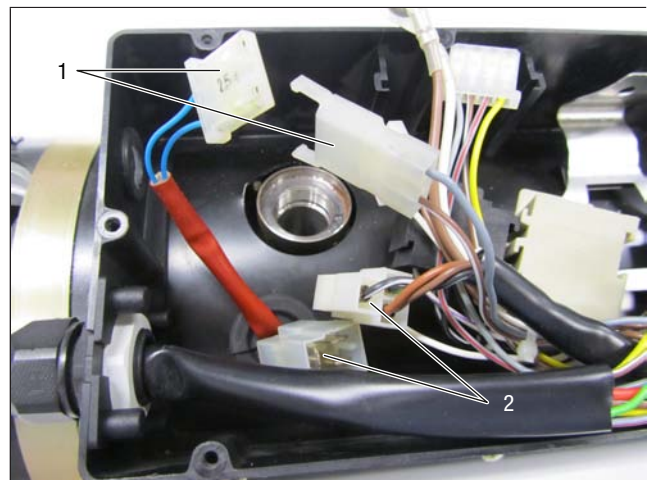

- 1 3 pin plug-in connection from the flame sensor cable loom
- 2 3 pin plug-in connection from the electric motor cable loom



- 1 Safety housing with cable loom

PLEASE NOTE!

NOTES FOR THE ASSEMBLY:

Tightening torque for safety housing fixing screw: $1.4^{+0.5}$ Nm

5 REPAIR INSTRUCTIONS

REPAIR STEP 10

DISMANTLE OUTER JACKET, HOOD AND BRACKETS

To dismantle the outer jacket, complete [Repair step 1 – 9](#) first.

- Dismantle the holder from the control box.
- Dismantle the rubber grommet for the flame sensor cable loom and the electric motor cable loom.
- Push the flame sensor cable loom and the electric motor cable loom back through the openings in the outer jacket and into the inner area of the heater.
- Dismantle the protective bracket from the fuel connection.
- Remove the fuel connection grommet.
- Unscrew the fixing screws of the outlet hood and remove the outlet hood.
- Undo both clips and remove both brackets.
- Unscrew the fixing screws of the outer jacket at the carrier and at the jacket overlap.
- Undo both clips completely and remove from the heater.
- Place the heater carefully on the inlet hood, bend open the outer jacket by approx. 70 mm and remove from the heater.

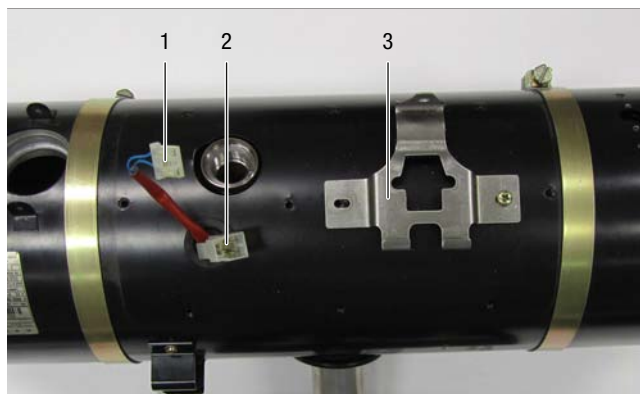

- 1 3 pin connector housing, flame sensor cable loom
- 2 3 pin connector housing, electric motor cable loom
- 3 Control box holder

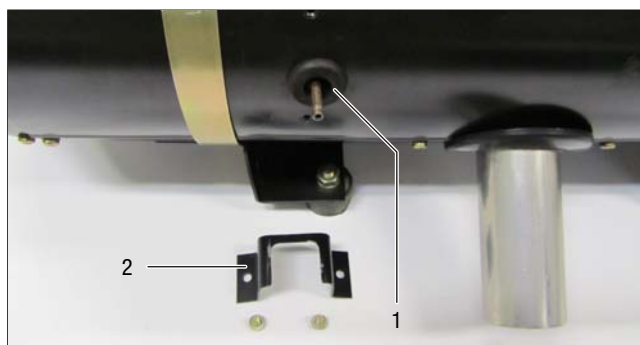

- 1 Fuel connection grommet
- 2 Protective bracket of the fuel connection



- 1 Outer jacket
- 2 Outlet hood
- 3 Brackets
- 4 Clips
- 5 Protective bracket, fuel connection
- 6 Fuel connection grommet

PLEASE NOTE!

The outer jacket is subject to mechanical stress.

NOTES FOR THE ASSEMBLY:

Tightening torque for outer jacket fixing screw: $1.4^{+0.5}$ Nm



- 1 Outer jacket
- 2 Fan with inlet hood
- 3 Heat exchanger

5 REPAIR INSTRUCTIONS

REPAIR STEP 11

DISMANTLE FLAME SENSOR

To dismantle the flame sensor, complete [Repair step 1 – 10](#) first.

- Remove fixing clip and remove flame sensor.

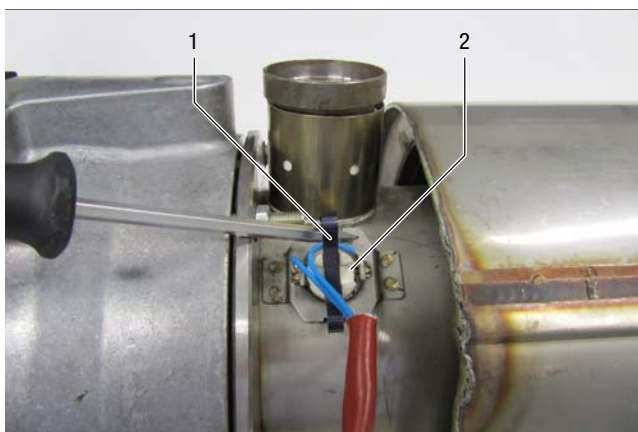

- Fixing clip
- Flame sensor

CHECK FLAME SENSOR

Use a digital multimeter to test the flame sensor.

Control values [see page 10](#).

If the measured value differs from the curve in the diagram, replace the flame sensor.

REPAIR STEP 12

DISMANTLE INLET HOOD

To dismantle the inlet hood, complete [Repair step 1 – 11](#) first.

- Unscrew the fixing screws of the inlet hood and remove inlet hood.

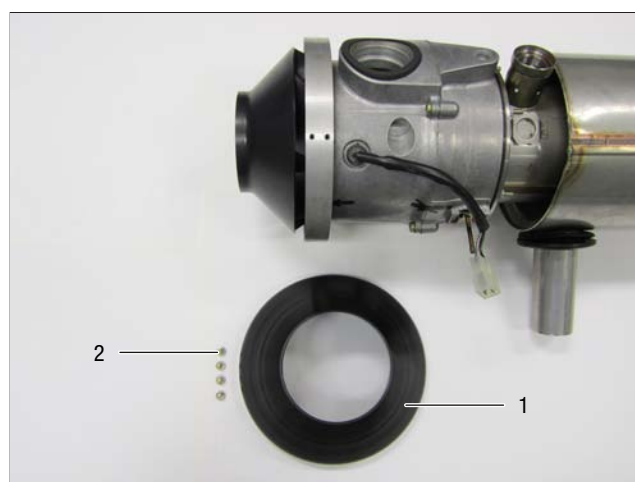
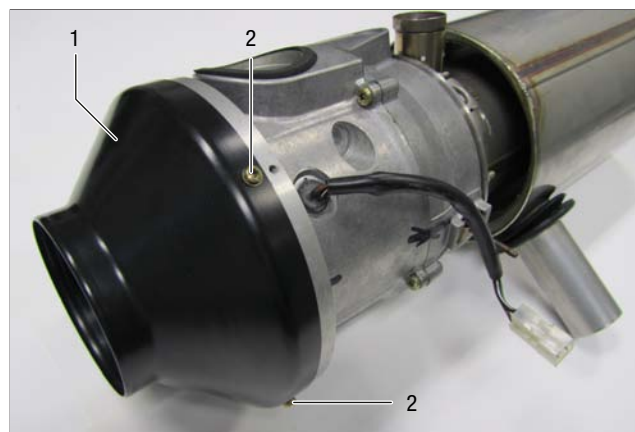

- Inlet hood
- Retaining screw

5 REPAIR INSTRUCTIONS

REPAIR STEP 13

DISMANTLE BLOWER FROM HEAT EXCHANGER

To dismantle the blower from the heat exchanger, complete [Repair step 1–12](#) first.

- Undo the fixing nuts and remove together with the spring lock washers.
- Remove the fan from the heat exchanger.
- Remove seal and clean sealing surface.

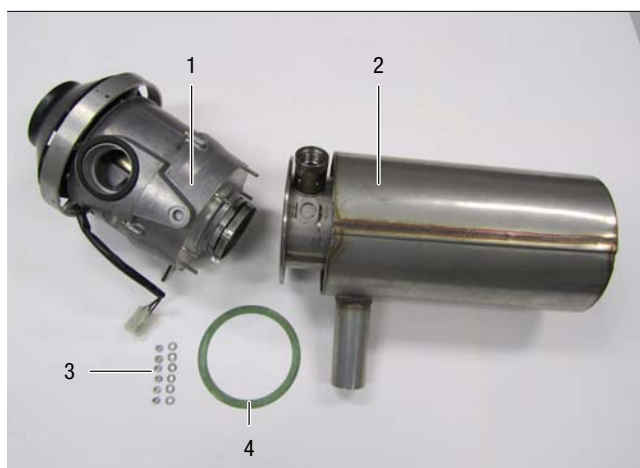
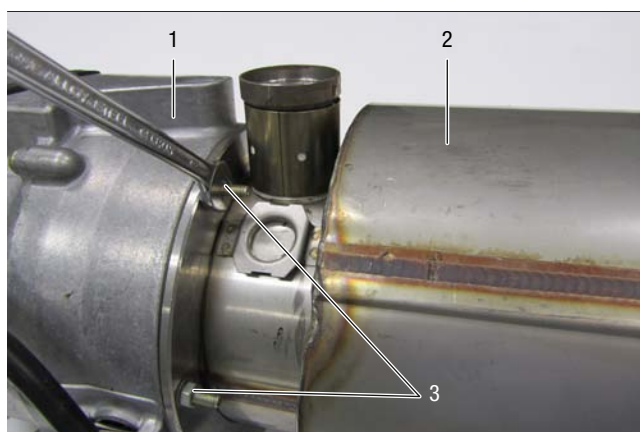

- 1 Fan
- 2 Heat exchanger
- 3 Hexagon nuts / spring lock washers
- 4 Seal

PLEASE NOTE!

NOTES FOR THE ASSEMBLY:

Renew the seam and spring lock washers.

Tightening torque, hexagon nuts: $5.6^{+0.6}$ Nm

REPAIR STEP 14

DISMANTLE IMPELLER

To dismantle the blower from the heat exchanger, complete [Repair step 1–13](#) first.

- Pull (Benzing) retaining ring from the blower shaft and remove impeller.

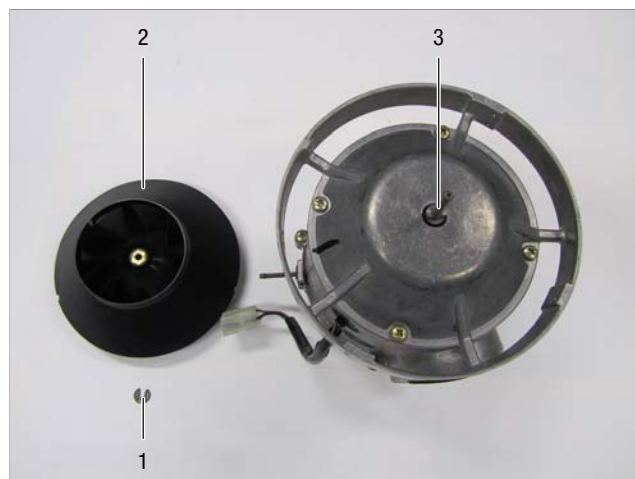

- 1 (Benzing) retaining ring
- 2 Impeller
- 3 Fan shaft

⚠ ATTENTION!

Renew (Benzing) retaining ring for the impeller.

PLEASE NOTE!

NOTES FOR THE ASSEMBLY:

After installing the impeller, check it for free running.

5 REPAIR INSTRUCTIONS

REPAIR STEP 15

DISMANTLE COMBUSTION CHAMBER LINING

To dismantle the combustion chamber lining, complete [Repair step 1 – 13](#) first.

- Use a screw driver to pull the combustion chamber lining out of the heat exchanger.

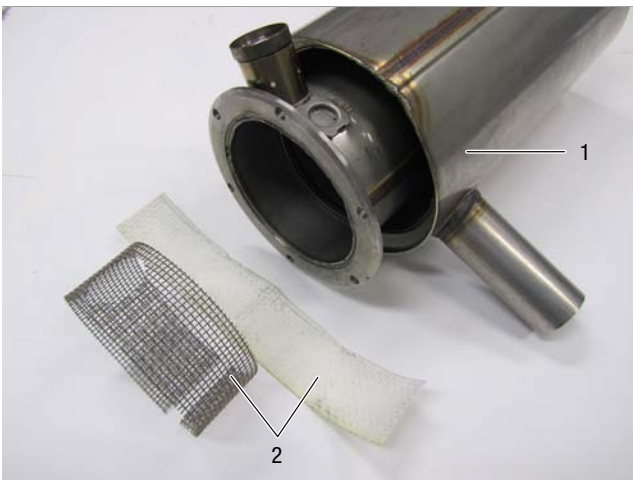

- 1 Heat exchanger
- 2 Combustion chamber lining

5 REPAIR INSTRUCTIONS

MEASURING THE FUEL QUANTITY

Before measuring the fuel quantity, check the following points in the fuel supply.

- Check the strainer in the metering pump.
- Check the laying of the fuel lines.
- Check fuel lines for leaks.
- Check and tighten the hose connections.
- Is the fuel removal installed according to the details in the technical description?
- For precise fuel measurement at least 11 volt / 22 volt, maximum 13 volt / 26 volt should be applied to the control box.

PREPARING FOR THE MEASUREMENT

- Disconnect fuel line from the heater and discharge into a measuring cylinder.
- Connect the voltmeter to the control box, connector A, terminal 3 (+) and terminal 4 (-).
- Switch on heater. If the fuel is uniformly pumped (begins approx. 25 – 55 sec after being switched on), the fuel line is full and vented.
- Switch off heater and empty measuring cylinder.

MEASUREMENT

- Switch on heater.
- The fuel begins to be pumped approx. 25 – 55 sec after switching on the heater.
- During the measurement, hold the measuring cylinder at the level of the glow plug.
- Read off electrical voltage at the voltmeter.
- After 90 sec. the pumping of the fuel is automatically switched off.
- Switch off the heater.
- Read off the quantity of fuel in the measuring cylinder.

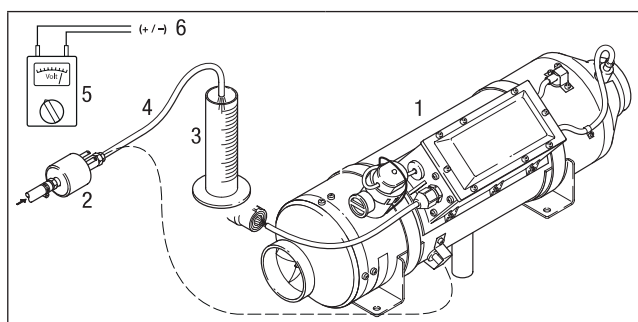

- | | |
|------------------------------|---------------------------------|
| 1 Heater | 4 Fuel line |
| 2 Metering pump | 5 Voltmeter |
| 3 Measuring cylinder (50 ml) | 6 Connection at the control box |

EVALUATION

- Transfer the measured fuel quantity into the diagram.
- The fuel consumption is ok, if the intersection of both values lies within the boundary curves.
- If the intersecting point is located outside, the metering pump must be replaced.

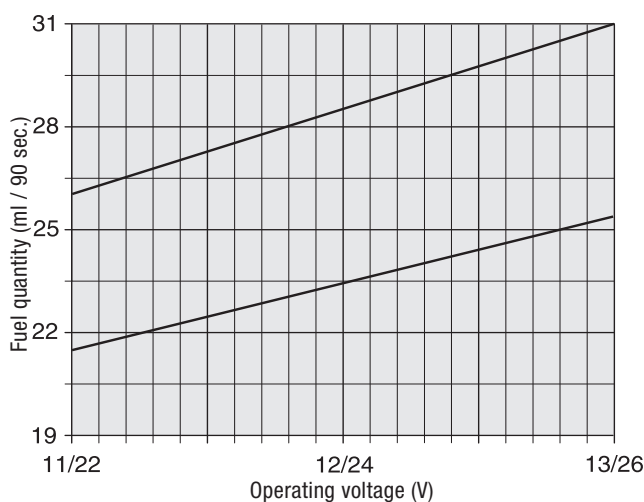

6 ELECTRICS

PAGE REFERENCES FOR THE CIRCUIT DIAGRAMS

Heater 8 L circuit diagram	Page 36
CONTROL UNITS	
Module timer with potentiometer	Page 38
Module timer with control unit	Page 38
Control unit with radio remote control TP5	Page 39
Diagnostic unit	Page 39
Control unit with Calltronic and mini timer	Page 40
Control unit with Calltronic	Page 41
Control unit with mini timer and radio remote control TP41i	Page 42
Control unit	Page 42
EasyStart R+ with control unit and EasyStart T	Page 44
EasyStart R+ with control unit	Page 45
EasyStart R with control unit and EasyStart T	Page 46
EasyStart R with control unit	Page 47
EasyStart T (2 times) with control unit	Page 48
EasyStart T with control unit	Page 49
Control unit with Calltronic 2010	Page 50

PARTS LIST, HEATER 8 L CIRCUIT DIAGRAM

1.1	Burner motor
1.1.1	Resistor for burner motor (partial load)
1.2	Glow plug
1.5	Overheating switch
1.7	Printed circuit board
1.8.5	Varistor
1.12	Flame sensor
1.13	Temperature sensor
2.1	Control box
2.2	Metering pump
2.3	Air solenoid valve (for combustion air)
2.5.1	Glow plug relay
2.5.5	Control relay
2.7	Main fuse
	12 volt = 30 A
	24 volt = 25 A
2.15.1	Room temperature sensor (control)
5.1	Battery

PLEASE NOTE!

Circuit diagram [see page 36](#).

CABLE COLOURS

rt	red	gn	green
bl	blue	ge	yellow
ws	white	vi	violet
sw	black	br	brown

Connectors and bush housings are shown from the cable inlet side.

6 ELECTRICS

PARTS LIST, CIRCUIT DIAGRAMS, CONTROL UNITS

- 2.5.9 Ventilate relay
- 2.15.1 Room temperature sensor*
- 2.15.9 Outside temperature sensor*
- 3.1.11 Control unit, round
- 3.1.12 Fault code query, optional
- 3.1.16 Radio remote control button
- 3.1.18 CALLTRONIC button
- 3.2.8 Timer (ADR – potentiometer)
- 3.2.9 Timer, ADR
- 3.2.12 Timer, mini – 12 / 24 volt
- 3.2.14 Lighting, mini timer – 12 volt only
- 3.3.6 Radio remote control stationary part TP41i
- 3.3.7 Radio remote control stationary part TP5
- 3.3.8 CALLTRONIC remote control
- 3.6.1 Cable harness for 3.1.11
- 3.8.3 Antenna
- 3.9.1 Diagnosis, JE diagnosis
 - a) Terminal “58” (lighting)
 - b) Terminal “15” (ignition)
 - c) Cable jumper required for normal operation (not ADR)
 - d) External ON / OFF button
 - e) For timer connection: Cut cable here X
 - f) Connection, radio module
 - z) Lighting, terminal 58

Insulate unused cable ends.

Connectors and bush housings are shown from the cable inlet side.

* for the temperature display of the control unit.

PLEASE NOTE!

Circuit diagrams [see page 38 – 42](#).

6 ELECTRICS

CIRCUIT DIAGRAM FOR CONTROL UNITS

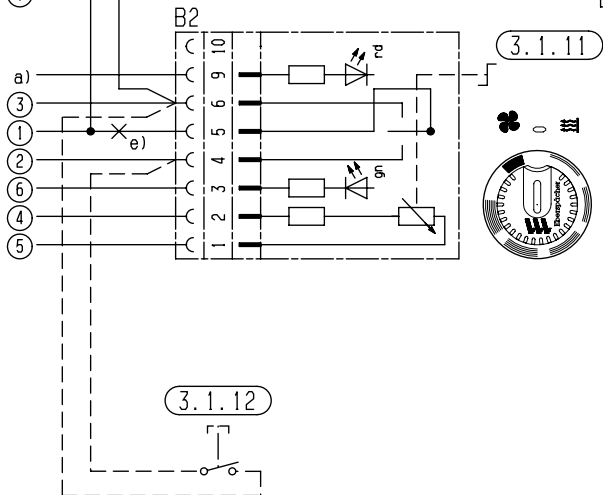
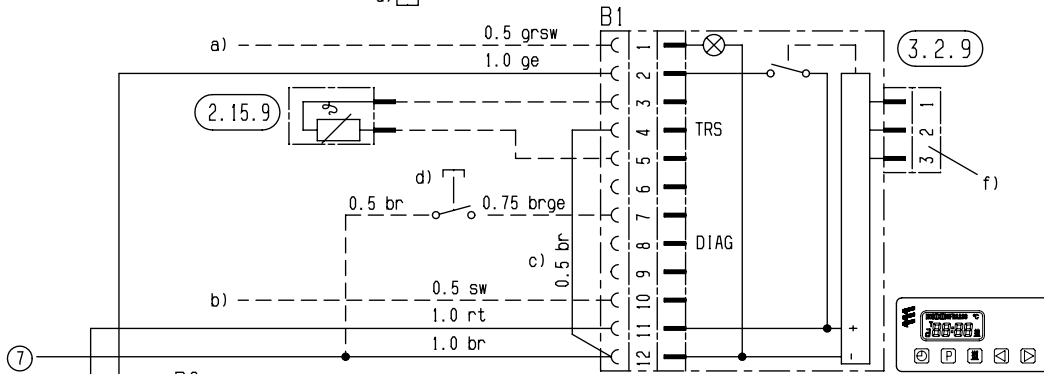
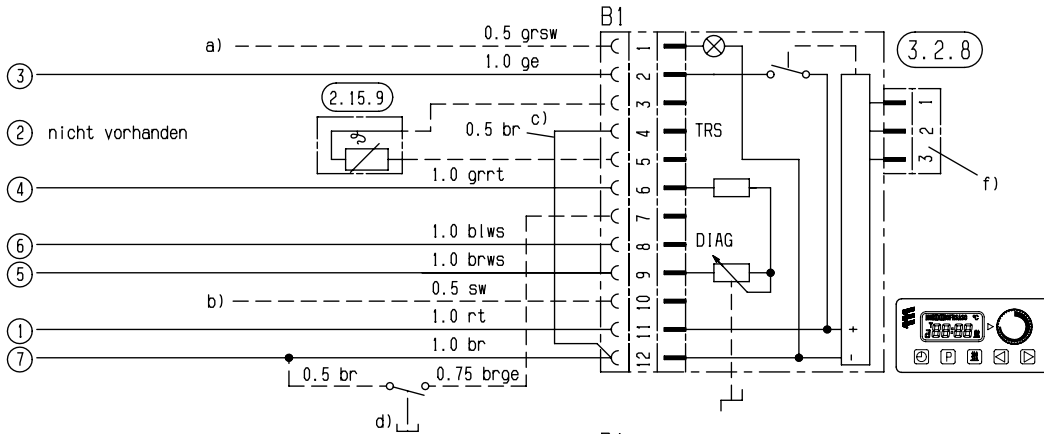

B1

B2

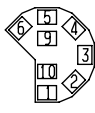
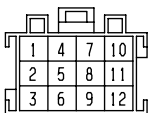

6 ELECTRICS

CIRCUIT DIAGRAM FOR CONTROL UNITS

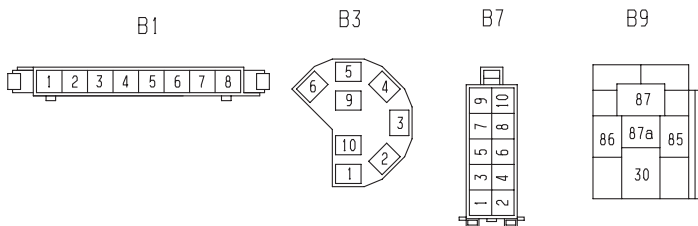
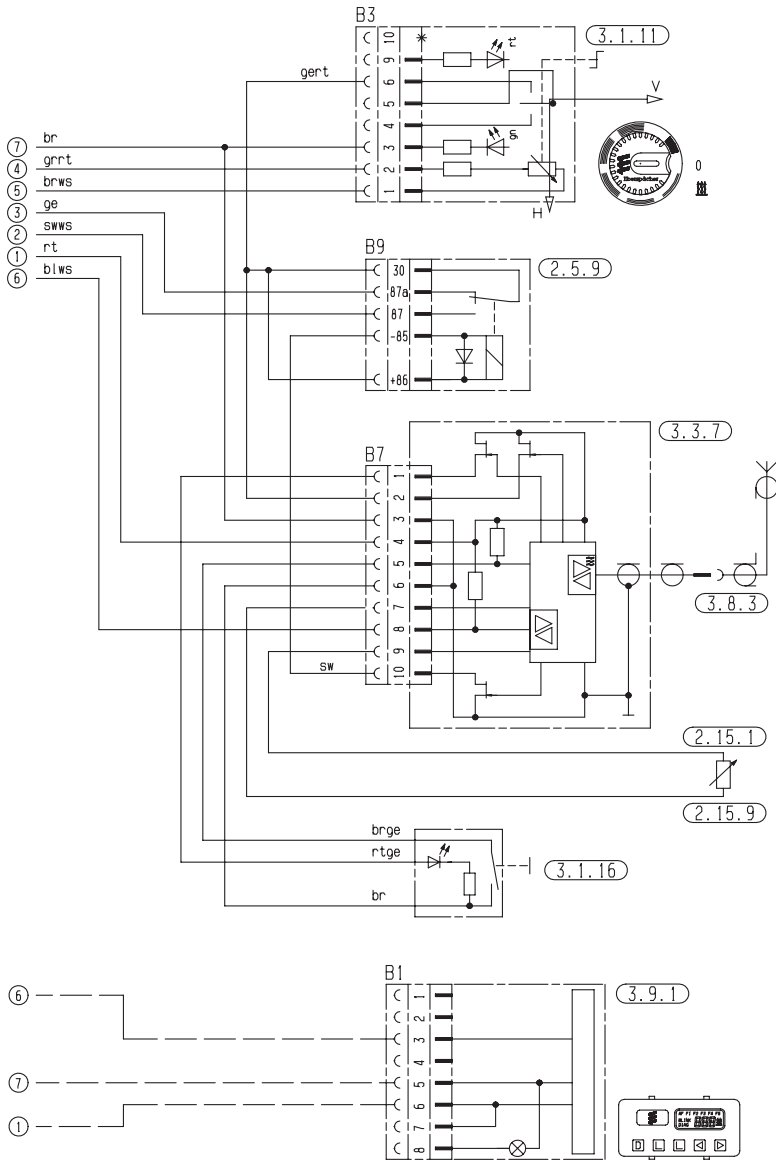

6 ELECTRICS

CIRCUIT DIAGRAM FOR CONTROL UNITS

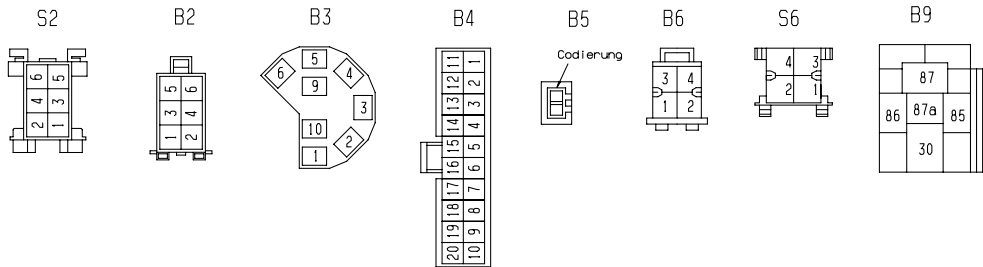
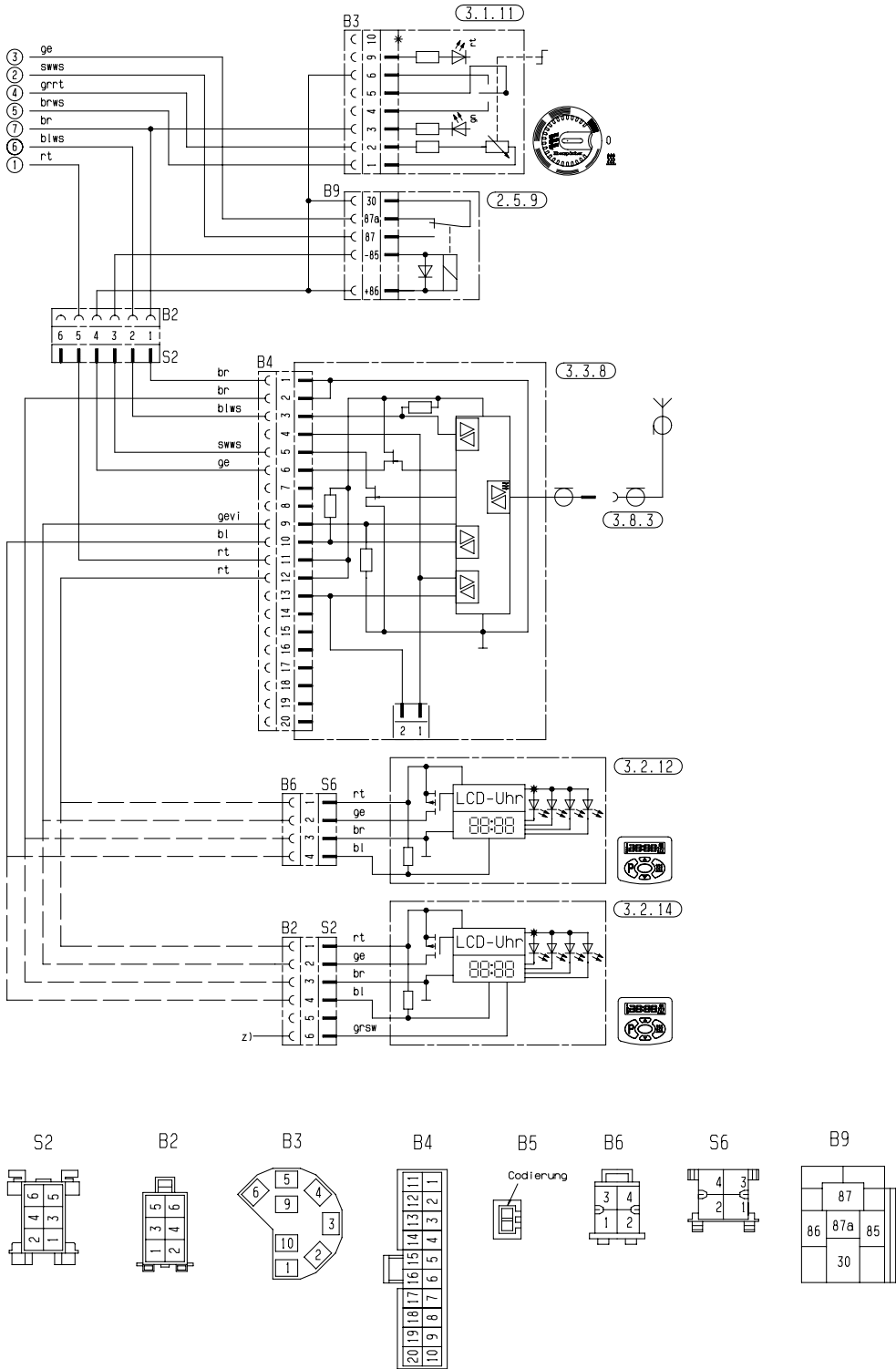

6 ELECTRICS

CIRCUIT DIAGRAM FOR CONTROL UNITS

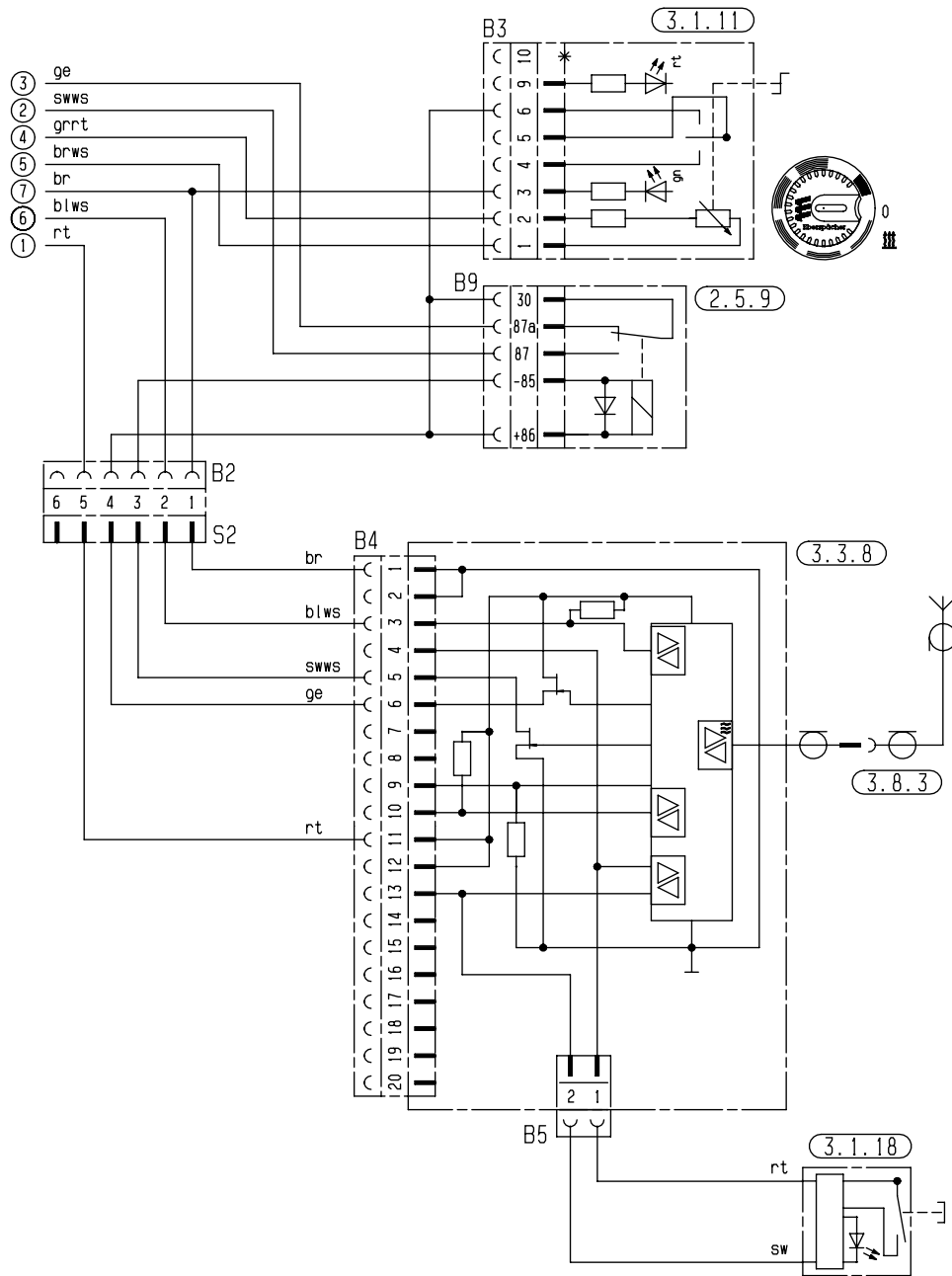

6 ELECTRICS

CIRCUIT DIAGRAM FOR CONTROL UNITS

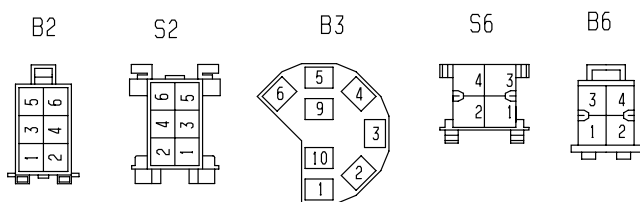
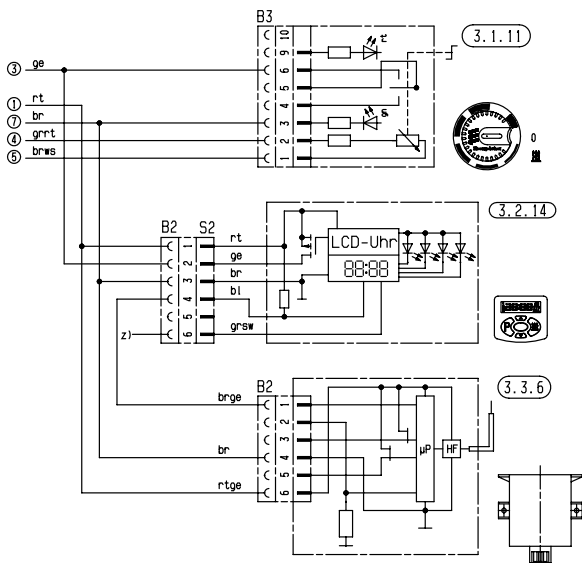
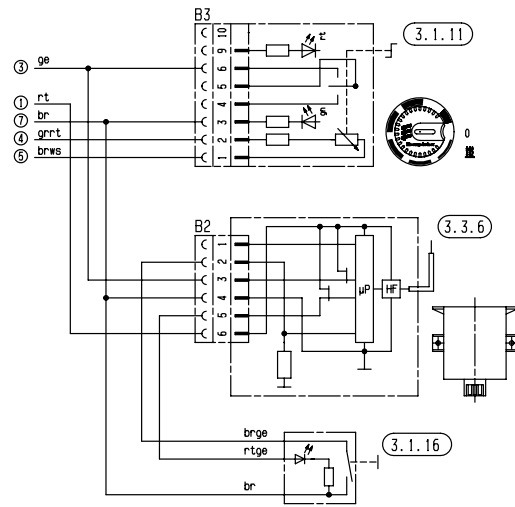
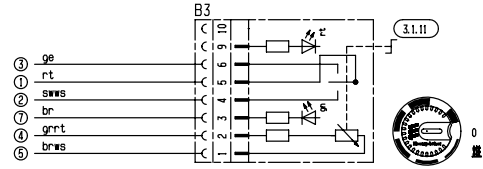
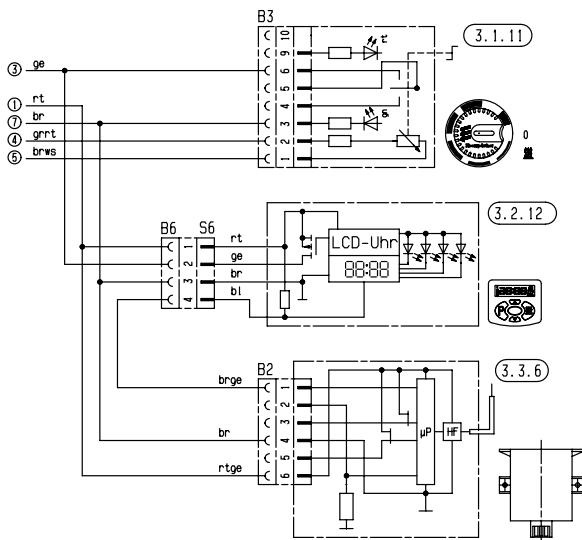

6 ELECTRICS

PARTS LIST FOR CIRCUIT DIAGRAM OF EASYSTART R⁺ / R / T CONTROL UNITS

- 2.5.9 “Ventilate” relay
- 2.15.1 Room temperature sensor*
(included in EasyStart R⁺ scope of supply,
optional for EasyStart R / T)
- 2.15.9 Outside temperature sensor (optional)*
- 3.1.7 “ON / OFF” button
- 3.1.11 Control unit, “round”
- 3.1.16 Radio remote control button
- 3.2.15 EasyStart T timer
- 3.3.9 Radio remote control, EasyStart R (stationary unit)
- 3.3.10 EasyStart R⁺ radio remote control (stationary unit)
- 3.6.1 Adapter cable
- 3.8.3 Antenna
- c) Terminal 58 (lighting)
- e) Connection, EasyStart T timer
- g) External “ON / OFF” button (optional)

Insulate unused cable ends.

Connectors and bush housings are shown from the cable inlet side.

* for the temperature display of the control unit.

PLEASE NOTE!

Circuit diagrams [see page 44 – 49](#).

6 ELECTRICS

CIRCUIT DIAGRAM FOR EASYSTART R+ CONTROL UNIT

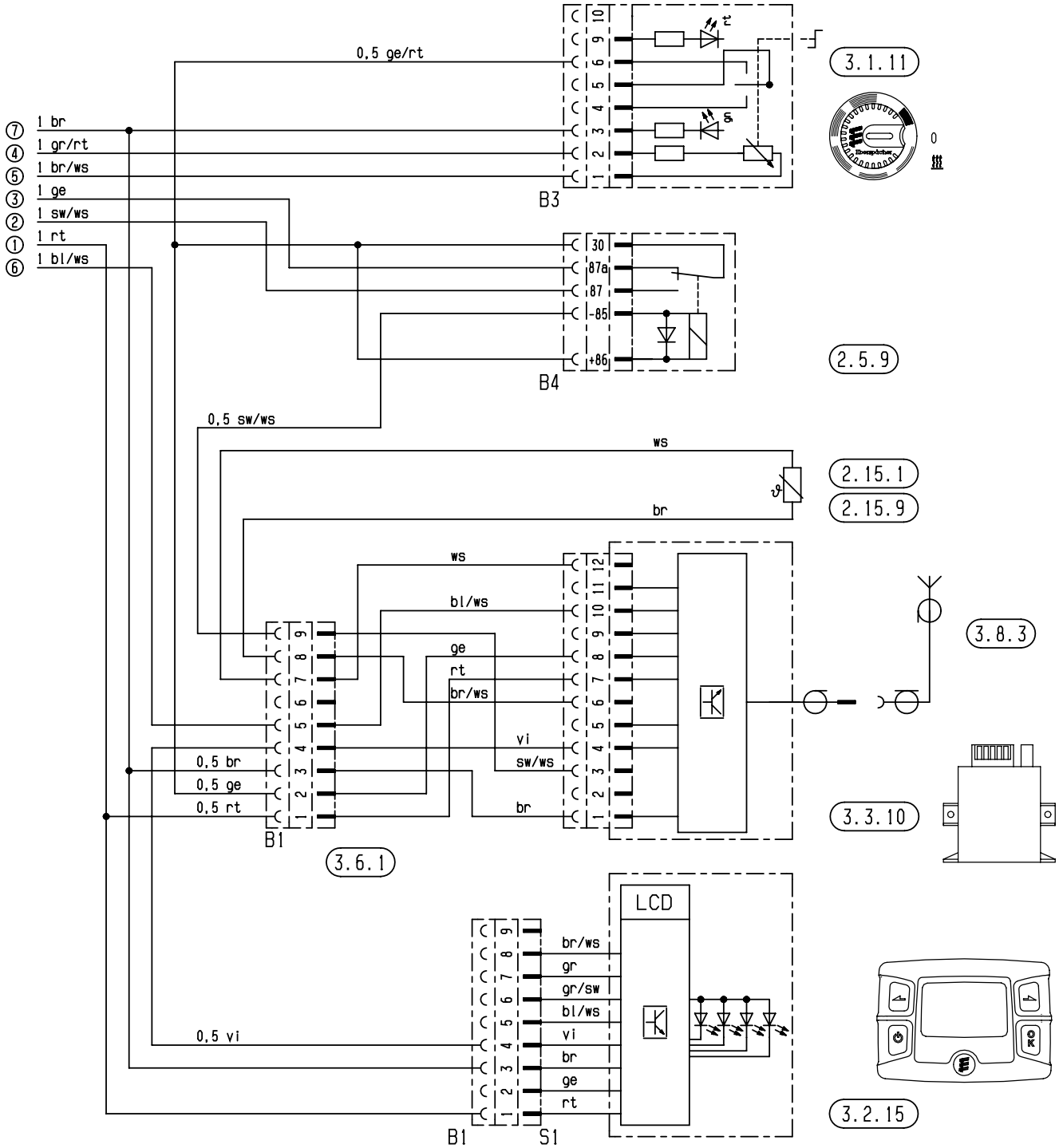

25 1890 00 97 01 C

6 ELECTRICS

CIRCUIT DIAGRAM FOR EASYSTART R+ CONTROL UNIT

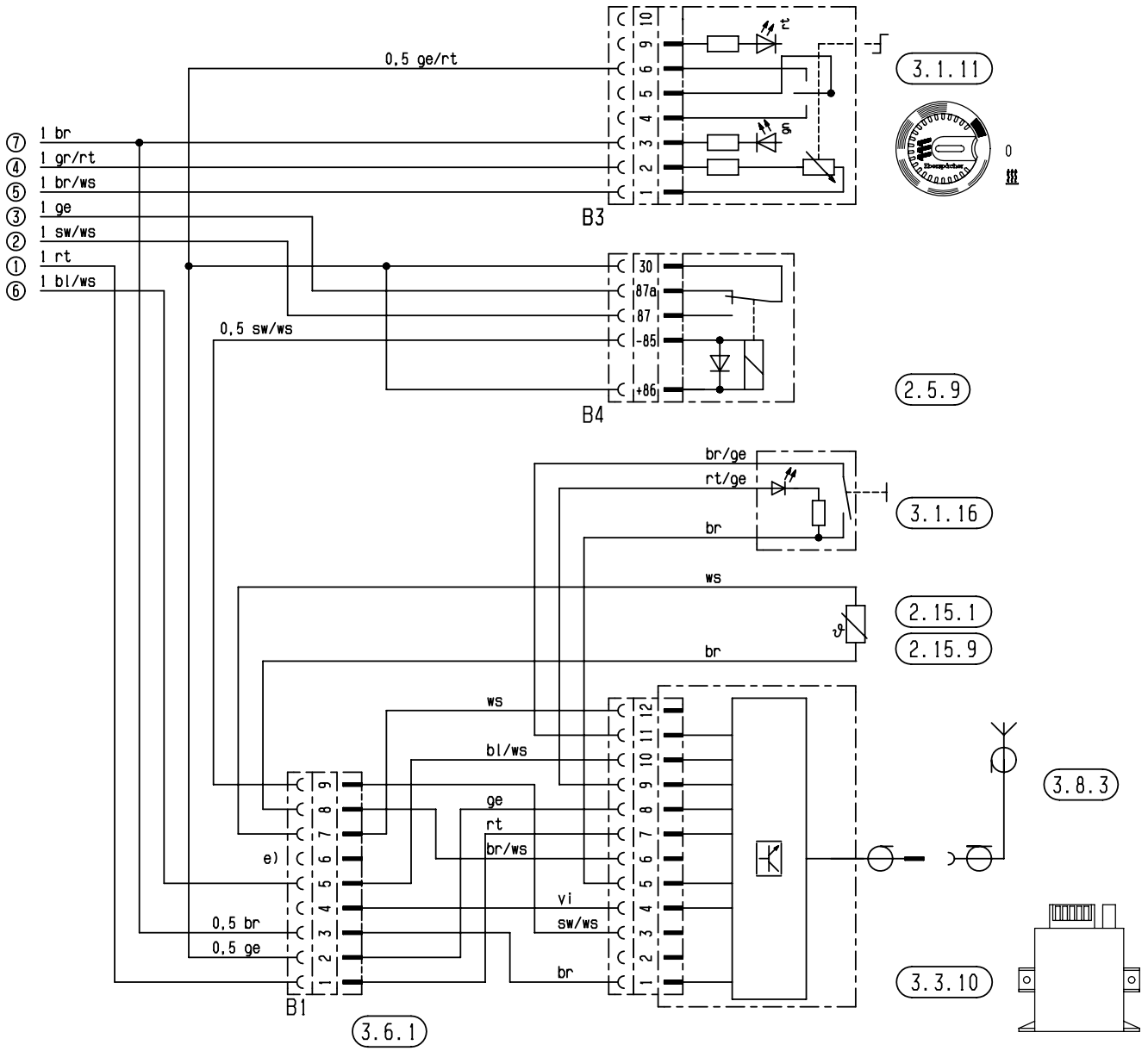

B4

B3

B1

S1

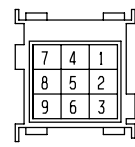
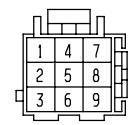
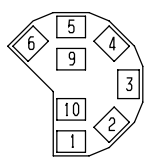
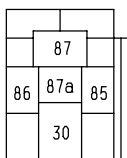

6 ELECTRICS

CIRCUIT DIAGRAM FOR EASYSTART R CONTROL UNIT

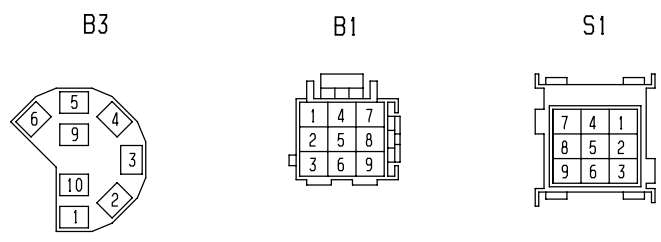
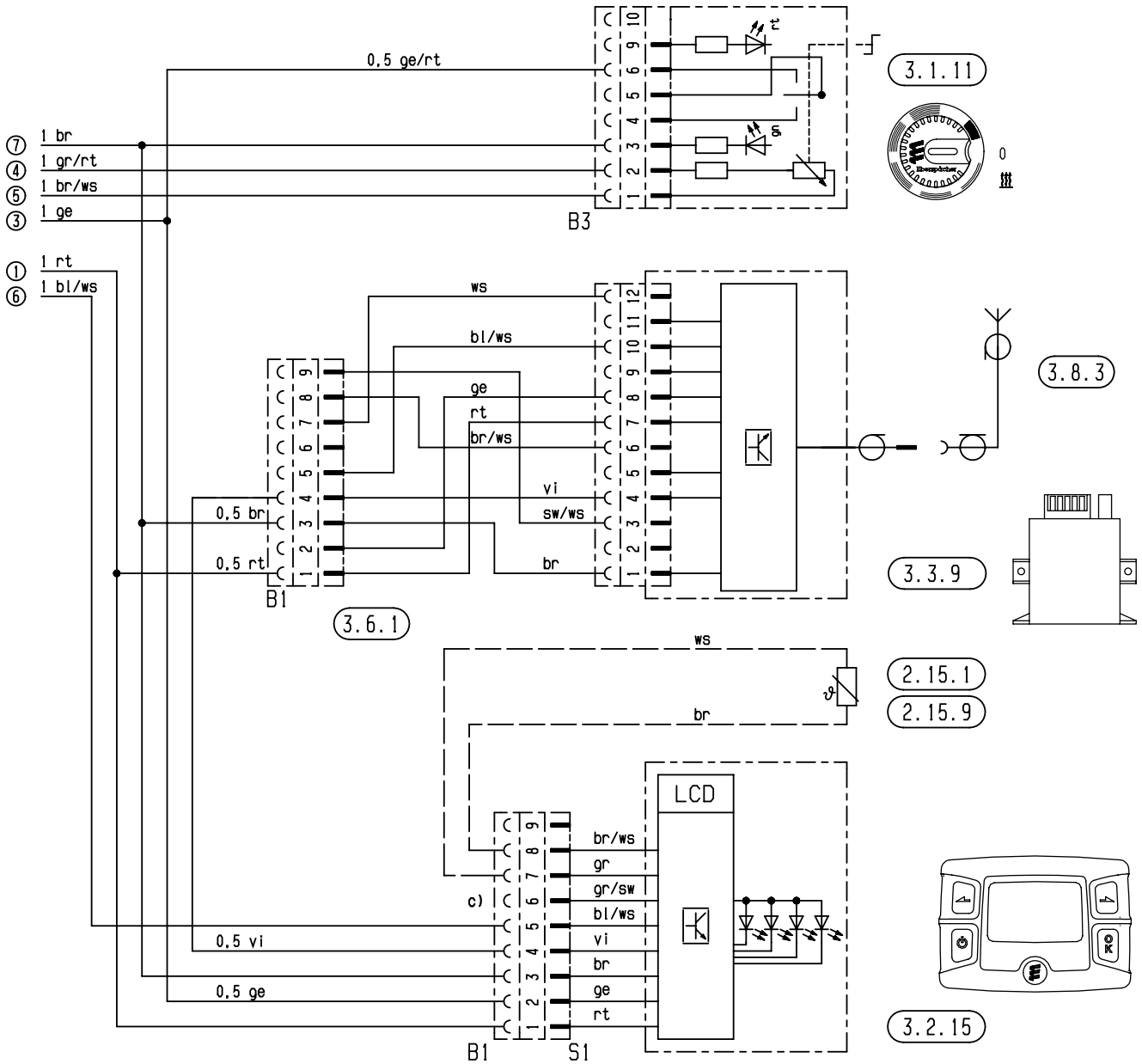

6 ELECTRICS

CIRCUIT DIAGRAM FOR EASYSTART R CONTROL UNIT

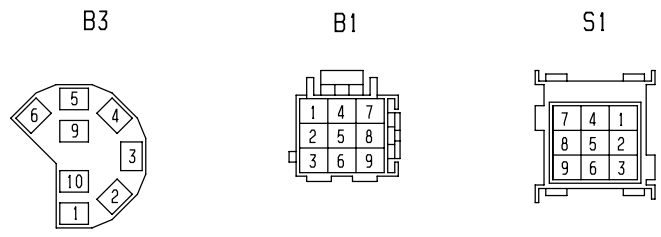
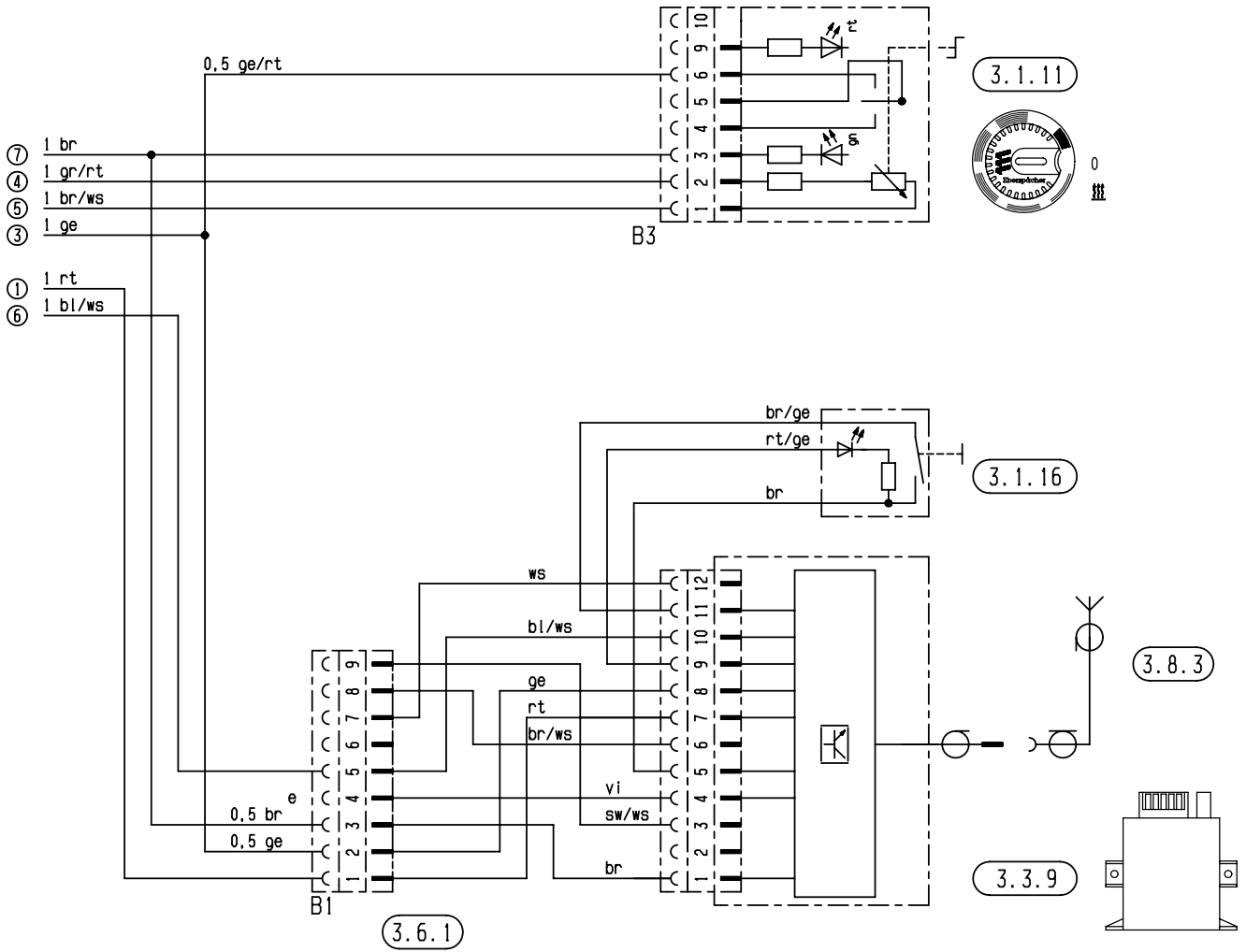

6 ELECTRICS

CIRCUIT DIAGRAM FOR EASYSTART T CONTROL UNIT

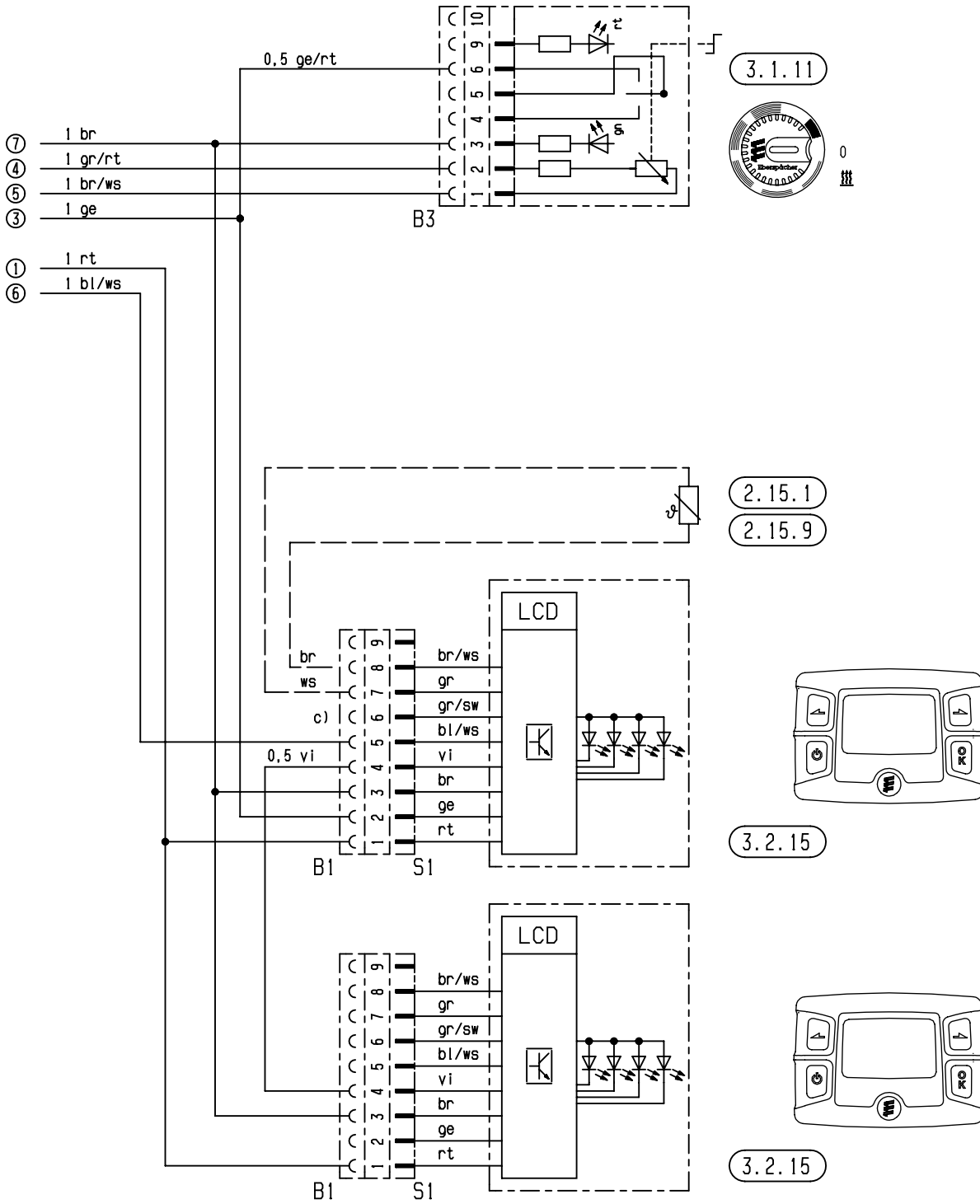

25 1890 00 97 03

6 ELECTRICS

CIRCUIT DIAGRAM FOR EASYSTART T CONTROL UNIT

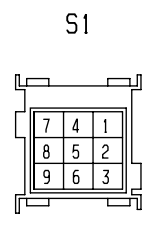
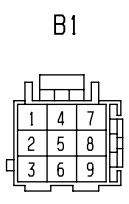
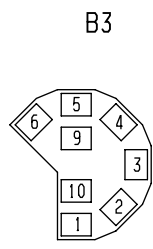
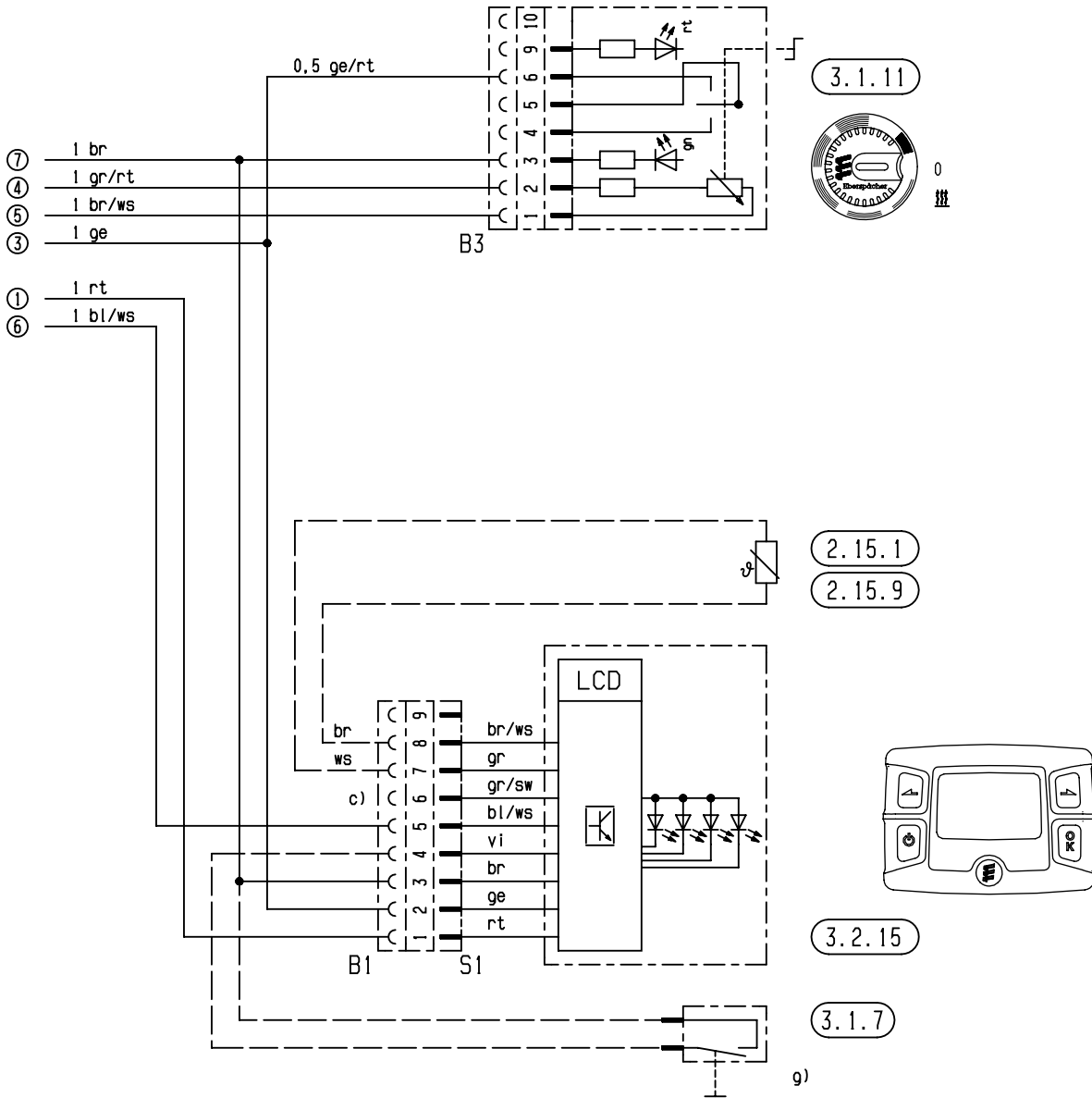

6 ELECTRICS

CIRCUIT DIAGRAM FOR CALLTRONIC (VERSION II FROM 2010)

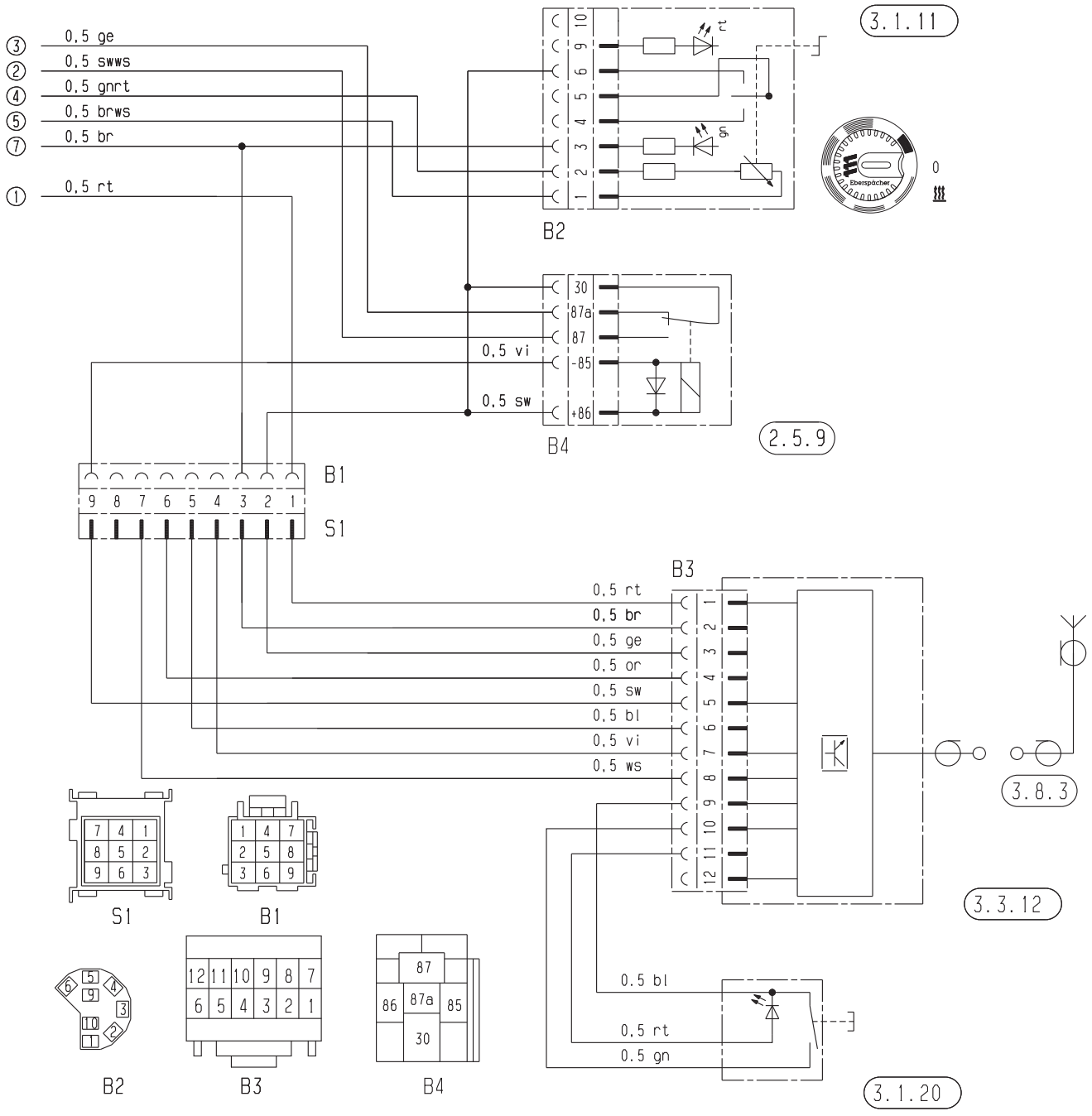

25 1890 00 97 05 A

Parts list

- 2.5.9 "Ventilate" relay
- 3.1.11 Control unit, "round"
- 3.1.20 Button, CALLTRONIC
- 3.3.12 Calltronic (GSM module)
- 3.8.3 Antenna

7 SERVICE

CERTIFICATIONS

The high quality of Eberspächer's products is the key to our success. To guarantee this quality, we have organised all work processes in the company along the lines of quality management (QM). Even so, we still carry out a large number of activities for continual improvement of product quality in order to keep pace with the constantly growing requirements of our customers.

All the steps necessary for quality assurance are stipulated in international standards.

This quality is to be considered in a comprehensive sense. It affects products, procedures and customer / supplier relationships.

Officially approved public experts assess the system and the corresponding certification company awards a certificate.

Eberspächer has already qualified for the following standards:

QUALITY MANAGEMENT IN ACCORDANCE WITH EN ISO 9001:2000 AND ISO/TS 16949:1999

ENVIRONMENTAL MANAGEMENT SYSTEM IN ACCORDANCE WITH EN ISO 14001:1996

DISPOSAL

DISPOSAL OF MATERIALS

Old devices, defective components and packaging material can all be separated and sorted into pure-grade fractions so that all parts can be disposed of in an environmentally friendly way or their materials can be recycled.

Electric motors, control boxes and sensors (e.g. temperature sensors) are deemed to be "electronic scrap".

DISMANTLING THE HEATER

The heater is dismantled according to the repair stages in the current troubleshooting / repair instructions.

PACKAGING

The packaging of the heater can be kept in case it has to be sent back.

EC DECLARATION OF CONFORMITY

With regard to the product named in the following

HEATER TYPE 8 L

we herewith confirm that it conforms with the essential safety requirements stipulated in the directive of the EU Council on the approximation of the laws of the Member States relating to Electromagnetic Compatibility (89 / 336 / EEC).

This declaration applies to all heaters produced according to the D 8 LC production drawings – which are part of this declaration.

The following standards / directives have been used to assess the product with regard to electromagnetic compatibility:

- EN 50081 – 1 Electromagnetic compatibility. Generic emission standard. Residential, commercial and light industry
- EN 50082 – 1 Electromagnetic compatibility. Generic immunity standard. Residential, commercial and light industry
- 72 / 245 / EEC – amendment status 95 / 54 / EC Interference suppression in motor vehicles.

7 SERVICE

LIST OF ABBREVIATIONS

ADR

European agreement about the international transport of dangerous goods on the road (ADR).

A

Current intensity in ampere

V

Voltage in volt

W

Power in watt

Headquarters:

Eberspächer Climate Control Systems

GmbH & Co. KG

Eberspächerstraße 24

73730 Esslingen

Hotline: 0800 1234300

Fax hotline: 01805 262624

info@eberspaecher.com

www.eberspaecher.com

