



J. Eberspächer
Eberspächerstr. 24
D-73730 Esslingen
Telefon (zentral)
(07 11) 939 - 00
Telefax
(07 11) 939 - 05 00

For heater designs

B 5 W

- 20 1645 05 00 00 - 12 V with safety thermal cutout fuse
- 20 1677 05 00 00 - 12 V with safety thermal cutout switch
- 20 1690 05 00 00 - 12 V with safety thermal cutout switch

D 5 W

- 25 1599 05 00 00 - 12 V with safety thermal cutout fuse
- 25 1600 05 00 00 - 24 V with safety thermal cutout fuse

- 25 1670 05 00 00 - 12 V with safety thermal cutout switch
- 25 1732 05 00 00 - 12 V with safety thermal cutout switch
- 25 1671 05 00 00 - 24 V with safety thermal cutout switch
- 25 1733 05 00 00 - 24 V with safety thermal cutout switch

Contents

	Page		Page
In the event of faults, first check the following points	2	Removing and installing the safety thermal cutout fuse	13
Function and fault test	3-5	Removing and installing the partial load resistor	13
Control in heating operation	6	Removing and installing the water pump	14
Flow chart with test signals	7	Removing and installing the combustion air blower	14
Wiring diagram	8, 9	Removing and installing the burner	14
Repair instructions	10	Removing and installing the heat exchanger	15
Repair procedures	11	Removing the cap complete	15
Removing and installing the glow plug	11	Measuring the fuel quantity	16
Removing the cap	12		
Removing and installing the temperature sensor	12		
Removing and installing the flame sensor	12		

In the event of faults, first check the following points

1. Fuel in the tank?
2. Heater lever (water valve) properly in the "Warm" position?
3. Fuses OK?
4. Electric lines, connectors, connections OK?
5. Do combustion air silencer and exhaust line have free passage?
6. Is the water pump running?

If not → check whether there is voltage at the motor,

if so → replace water pump,

if not → replace control unit.

If the fault is still present, run a function and fault test using the test plug on the control unit.

Function and fault test

The heater can be installed in the vehicle or set up on a test stand.

All connections required for functioning must be made.

The following can be used as indicators:

1. LED
2. Bulb (max. 3 W)
3. Acoustic signal

The indicator connections are connected to the "Test" plug and "S" plug on the control unit.

Switch the heater on and observe the indicator signal.

Compare the signal with those set forth on pages 3–5 and remedy the fault as described under "Remedy".

If the fault is not recognised by the control unit, see page 5.

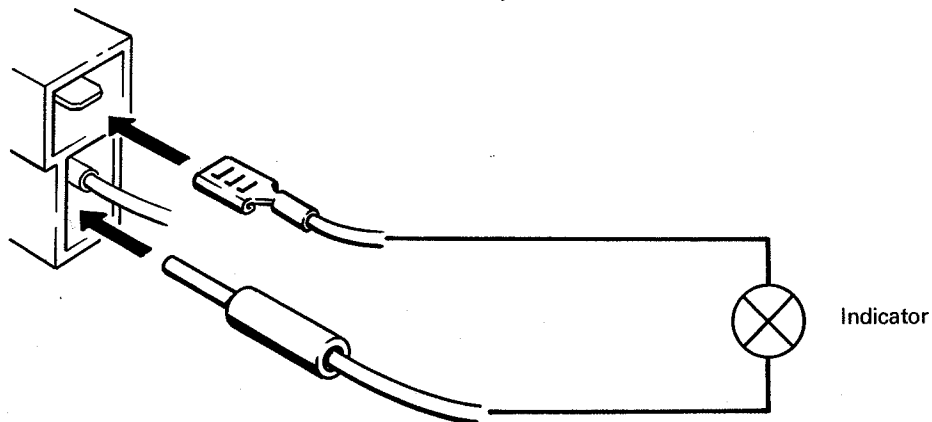

Indication		Cause	Remedy
	<p style="text-align: center;">Signal</p> <p style="text-align: center;">0 1 2 3 4 5 6 7 8 9 10 11 12 13</p>		
1 Start, heating phase (trouble-free operation)		_____	_____
2 Normal operation (trouble-free operation)		_____	_____
3 Delayed shut-off and restart (start while heater still not shut off)		Heater still not shut off Water temperature still above the triggering point for the temperature sensor (approx. 70°C) Temperature sensor interruption	Wait until end of delayed shut-off Wait until the temperature falls below the triggering pint Replace temperature sensor (see p. 12)
4 Warning: power supply (undervoltage or overvoltage)		Undervoltage Overvoltage	Charge battery Check controller
5 Overheat (automatic cut-out)		Electric line to metering pump interrupted Insufficient cooling water Water circuit not properly bled Water pump defective	Check line Top up cooling water Bleed water circuit (see p.15) Replace water pump (see p. 14) Replace safety thermal cutout fuse (see p. 13)
6 Flame sensor short-circuit		Short-circuit in the flame sensor	Remove flame sensor (see p. 12)
7 Flame out L O W (Flame goes out by itself in "Low" position)		Insufficient fuel Speed of blower not reduced (change in sound, change in voltage at terminal C 5 on control unit)	Measure fuel quantity (see p. 16) Replace partial load resistor (see p. 13) Replace control unit
8 Flame out H I G H (Flame goes out by itself in "High" position)		Insufficient fuel Vapour lock in the fuel line? Flame sensor fouled/defective	Measure fuel quantity (see p. 16) Fuel line gets too hot, change laying arrangement Clean/replace flame sensor (see p. 12)



Indication	Signal														Cause	Remedy
	0	1	2	3	4	5	6	7	8	9	10	11	12	13		
9 Glow plug defective	█	█	█	█				█	█	█	█				Glow plug fuse (16 A) defective Glow plug defective Flame sensor fouled	Replace fuse Replace glow plug (see p. 11) Remove and clean flame sensor (see p. 12)
10 Burner motor defective	█	█	█	█				█	█	█	█				Heater fuse (8 A) defective. Electric motor defective or blower blocked	Replace fuse Replace blower (see p. 14)
11 Cut-out due to undervoltage	█	█	█	█				█	█	█	█				Undervoltage Corrosion on electrical connections	Charge battery, check battery Clean electrical connections
12 Cut-out due to overvoltage	█	█	█	█				█	█	█	█				Overvoltage	Check controller Connect heater directly to battery and not to dynamo regulator
13 Non-start Safety time exceeded and automatic cut-out	█	█	█	█				█	█	█	█				No fuel Metering pump seizure Short-circuit at metering pump No pulses at metering pump Fuel line not filled Insufficient fuel Defective glow plug Automatic cut-out after 3-5 mins Flame sensor wrongly poled Flame sensor fouled Flame sensor interruption Insufficient fuel	Replace metering pump Check plug Replace control unit Restart, check fuel line Measure fuel quantity (see p. 16) Replace glow plug (see p. 11) Check connection against wiring diagram (see p. 8) Remove and clean flame sensor (see p. 12) Replace flame sensor (see p. 12) Measure fuel quantity (see p. 16)

Indication		Cause	Remedy
Faults not shown up by the indicator:			
Sooty combustion		Combustion air line/exhaust line clogged up Metering pump conveying too much Combustion air blower speed too low Deposits in heat exchanger	Remove clog Measure fuel quantity (see p.16) Replace blower (see p.14) Remove and clean heat exchanger (see p.15)
Heater does not regulate in "Low" setting No hot air in interior		Temperature sensor short-circuited (vehicle blower does not switch on above approx. 55°C water temperature) Heater lever to vehicle blower not switched on Vehicle blower relay defective Vehicle blower fuse (25 A) defective	Remove temperature sensor (see p.12) Open heater lever Switch on vehicle blower Replace relay Replace fuse



Control in heating operation

Control diagram

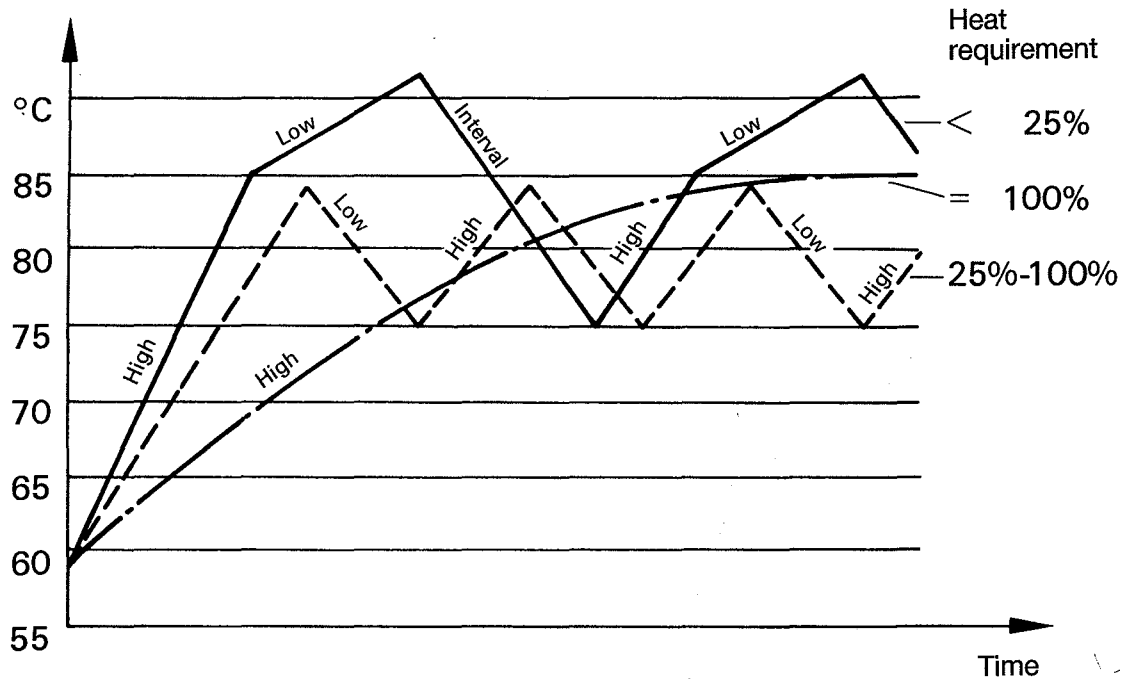

If the heater has ignited properly and is heating without trouble, the temperature sensor switches on the vehicle blower when the cooling water temperature is approx. 55°C.

Various operating conditions can now result in the heating circuit depending on the heat requirement.

Heat requirement 5000 W — — — — —

If the heat requirement is 5000 W and above, the heater always operates in the "High" setting. The cooling water temperature is between 55°C and 80°C.

Heat requirement between 1250 and 5000 W — — —

When the operating temperature reaches approx. 80°C, the temperature sensor switches the heater to the "Low" position. The speed of the combustion air blower and the fuel quantity are reduced to give a heating capacity of 1250 W. Since the heat requirement exceeds 1250 W, the cooling water temperature drops. When it reaches approx. 70°C, the heater switches back to the "High" setting.

Heat requirement less than 1250 W ———

When the operating temperature reaches approx. 80°C, the temperature sensor switches the heater to the "Low" setting. The speed of the combustion air blower and the fuel quantity are then reduced to give a heating capacity of 1250 W.

The low heat requirement causes the temperature to rise further. At approx. 85°C, the fuel feed is switched off, and the combustion air blower continues running for approx. 180 seconds (delayed shut-off).

The water pump and the vehicle blower remain in operation during the delayed shut-off and the now commencing control interval. The pilot lamp stays on.

Once the coolant has cooled down to approx. 70°C, the heater restarts with the "High" setting.

Flow chart with test signals

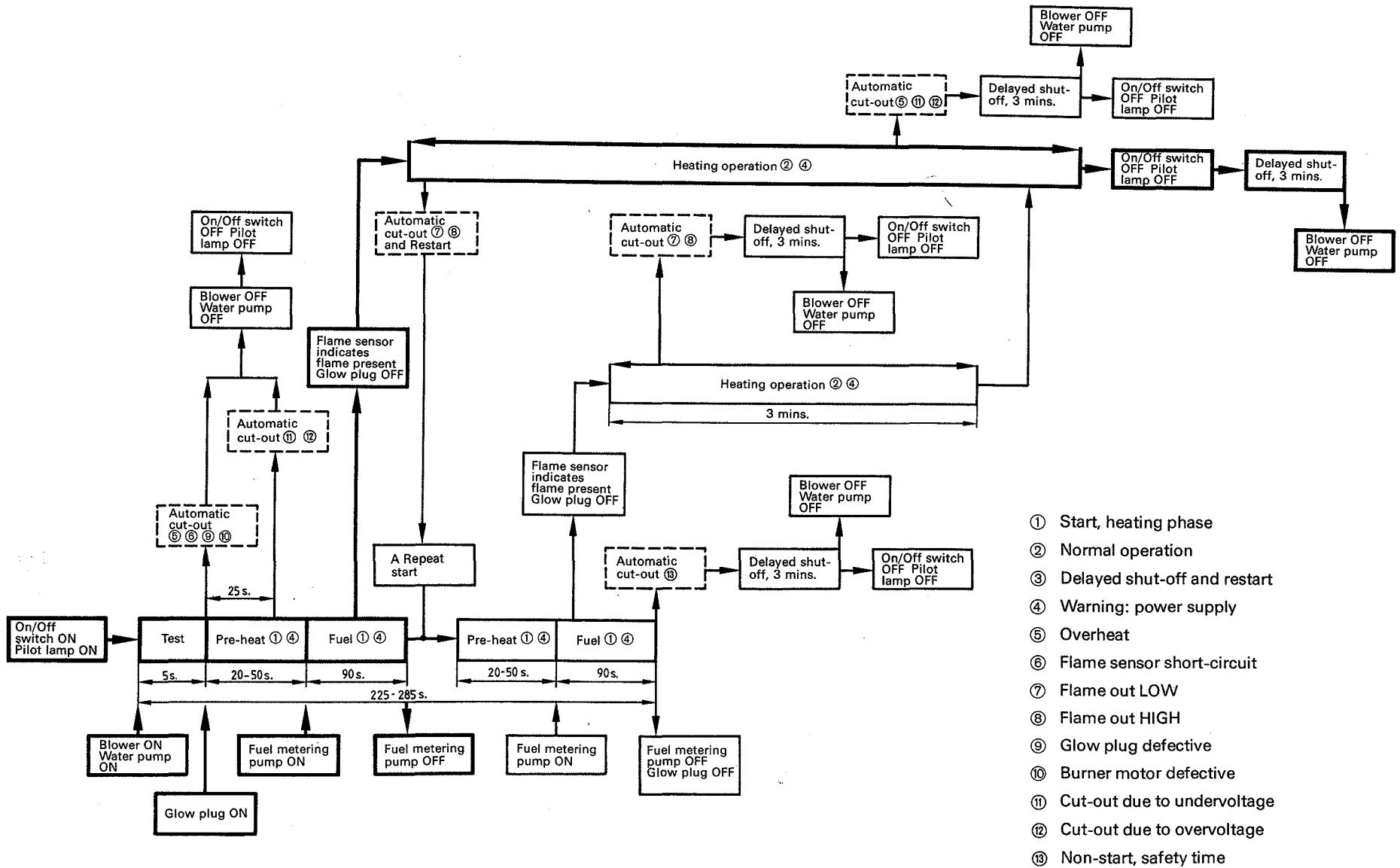

Wiring diagram – B/D 5 W 20 1645 25 1599 25 1670
20 1677 25 1600 25 1671

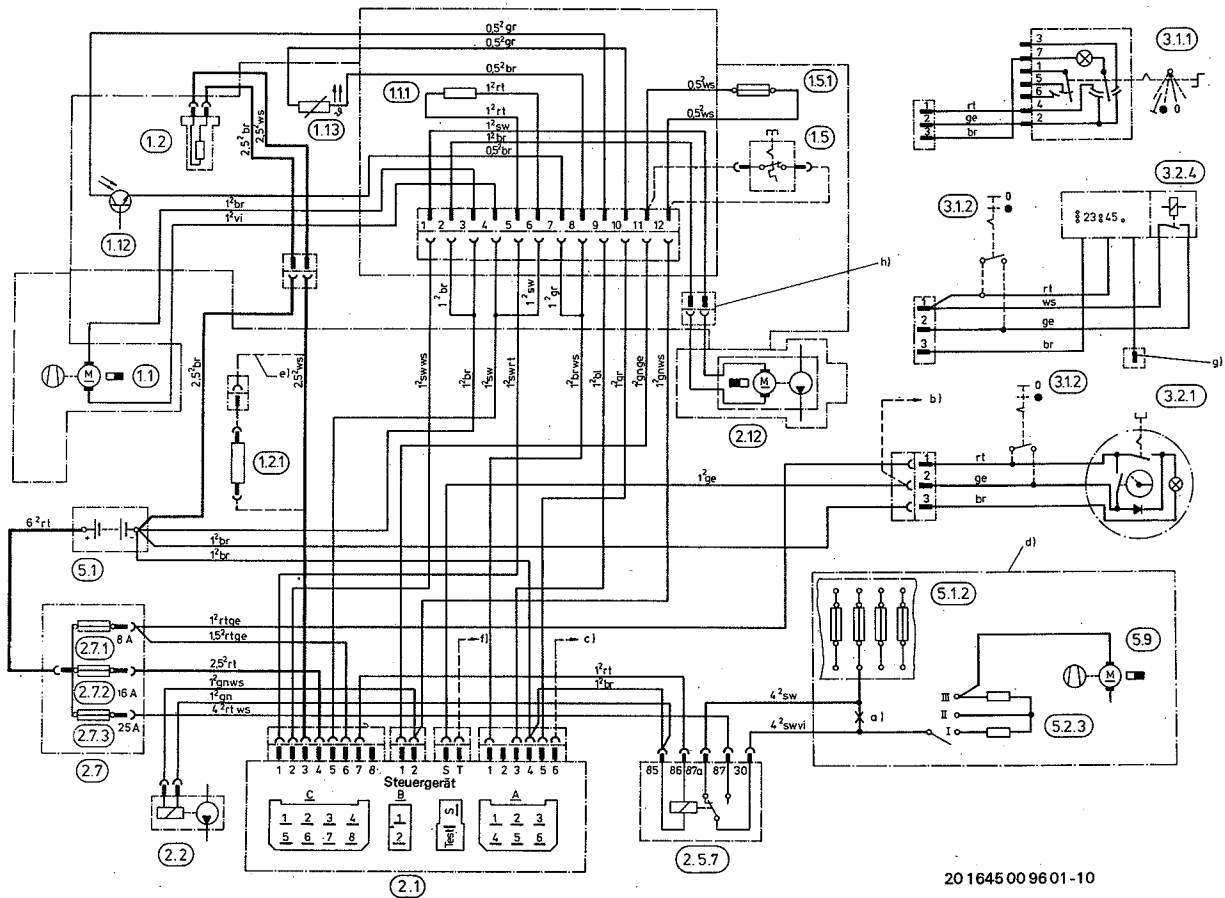

20 1645 00 96 01 - 10

Parts list for wiring diagram

- 1.1 Burner motor
- 1.1.1 Series resistor for partial load
- 1.5 Safety thermal cutout switch
- 1.5.1 Safety thermal cutout fuse
- 1.12 Flame sensor
- 1.13 Temperature sensor

- 1.2 Glow plug
- 1.2.1 Series resistor for glow plug at 24 V

- 2.1 Control unit
- 2.2 Fuel metering pump
- 2.5.7 Relay for switching on vehicle blower
- 2.7 Fuse box
- 2.7.1 Heater fuse, 8 A
- 2.7.2 Glow plug fuse, 16 A
- 2.7.3 Vehicle blower fuse, 25 A (or as for vehicle blower fuse)
- 2.12 Water pump

- 3.1.1 Universal switch
- 3.1.2 Switch (heating), continuous operation
- 3.2.1 Timer (analog)
- 3.2.4 Timer (digital)

- 5.1 Battery
- 5.1.2 Vehicle fuse box
- 5.9 Vehicle blower

- a) break
- b) if required, connection of relay coil for triggering water solenoid valve
- c) external control of water pump (if required)
- d) parts already provided in vehicle
- e) for 24 V only
- f) test (workshop)
- g) on terminal 15
- h) only for heater with separate water pump

measure voltage:
Between the control unit plugs A, terminal 4 and C, terminal 6

- Cable colours:**
- rt red
 - br brown
 - ws white
 - sw black
 - gn green
 - ge yellow
 - vi violet
 - gr grey

Wiring diagram - B / D 5 W 20 1690 25 1732 25 1733

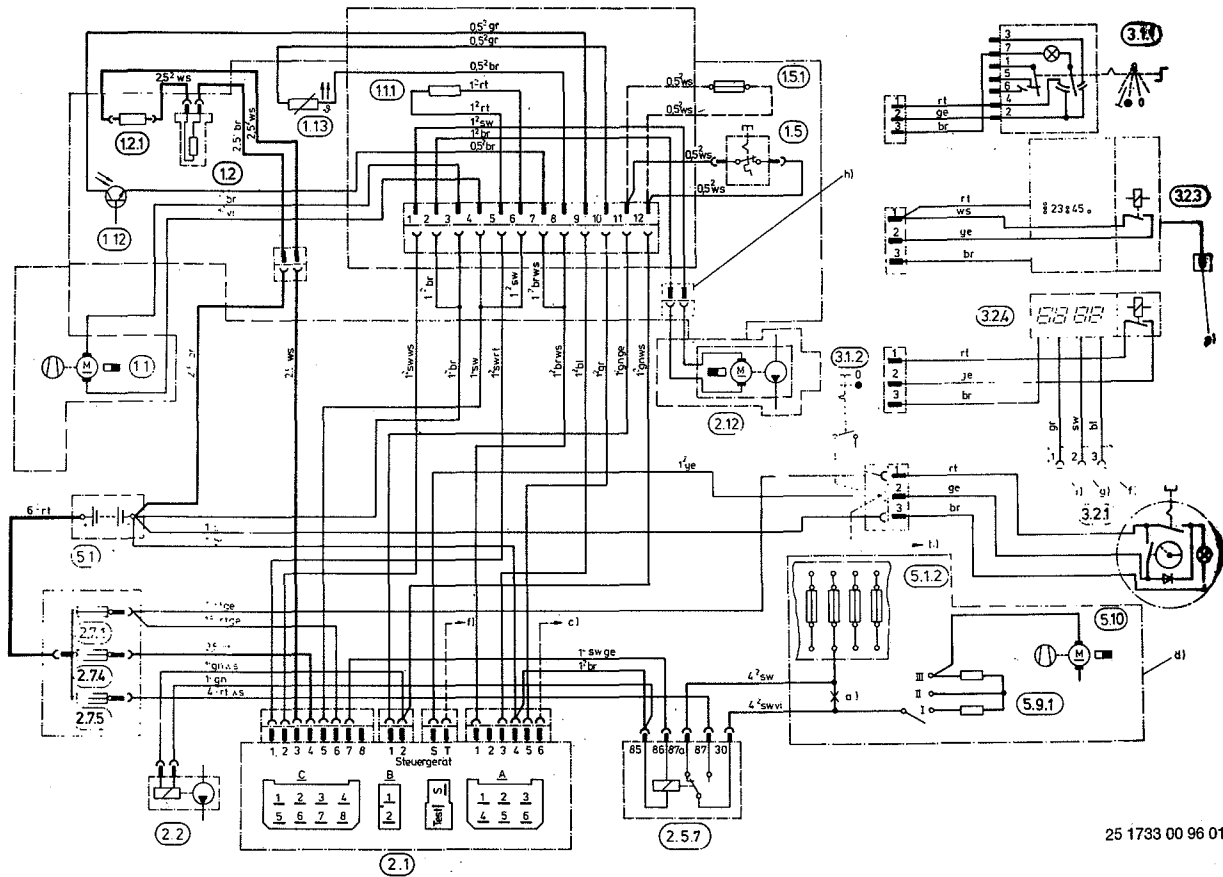

25 1733 00 96 01

Parts list

- 1.1 Burner motor
- 1.1.1 Series resistor for partial load
- 1.2 Glow plug
- 1.2.1 Series resistor for glow plug for 24 V
- 1.5 Safety thermal cutout switch
- 1.5.1 Safety thermal cutout fuse
- 1.12 Flame sensor
- 1.13 Temperature sensor
- 2.1 Control unit
- 2.2 Fuel metering pump
- 2.5.7 Relay for switching on vehicle blower
- 2.7.1 ON-switch fuse, 8 A
- 2.7.4 Glow plug fuse, 16 A
- 2.7.5 Vehicle blower fuse, 25 A
- 2.12 Water pump
- 3.1.1 Universal switch
- 3.1.2 Switch for continuous (heating) operation
- 3.2.1 Timer, analog, circular
- 3.2.4 Timer, digital, square
- 3.2.5 Timer, digital, rectangular
- 5.1 Battery
- 5.1.2 Vehicle fuse box
- 5.9.1 Blower switch
- 5.10 Blower

- a) break
- b) if required, connection of relay for triggering water solenoid valve
- c) external control of water pump (if required)
- d) parts already provided in vehicle
- f) Test (workshop)
- g) on terminal 15
- h) only for heater for separate water pump
- i) Timer illumination, terminal 58

measuring voltage:
between the control unit plugs A, terminal 4
and C, terminal 6

Cable colours:

- rt red
- br brown
- ws white
- sw black
- gn green
- ge yellow
- vi violet
- gr grey

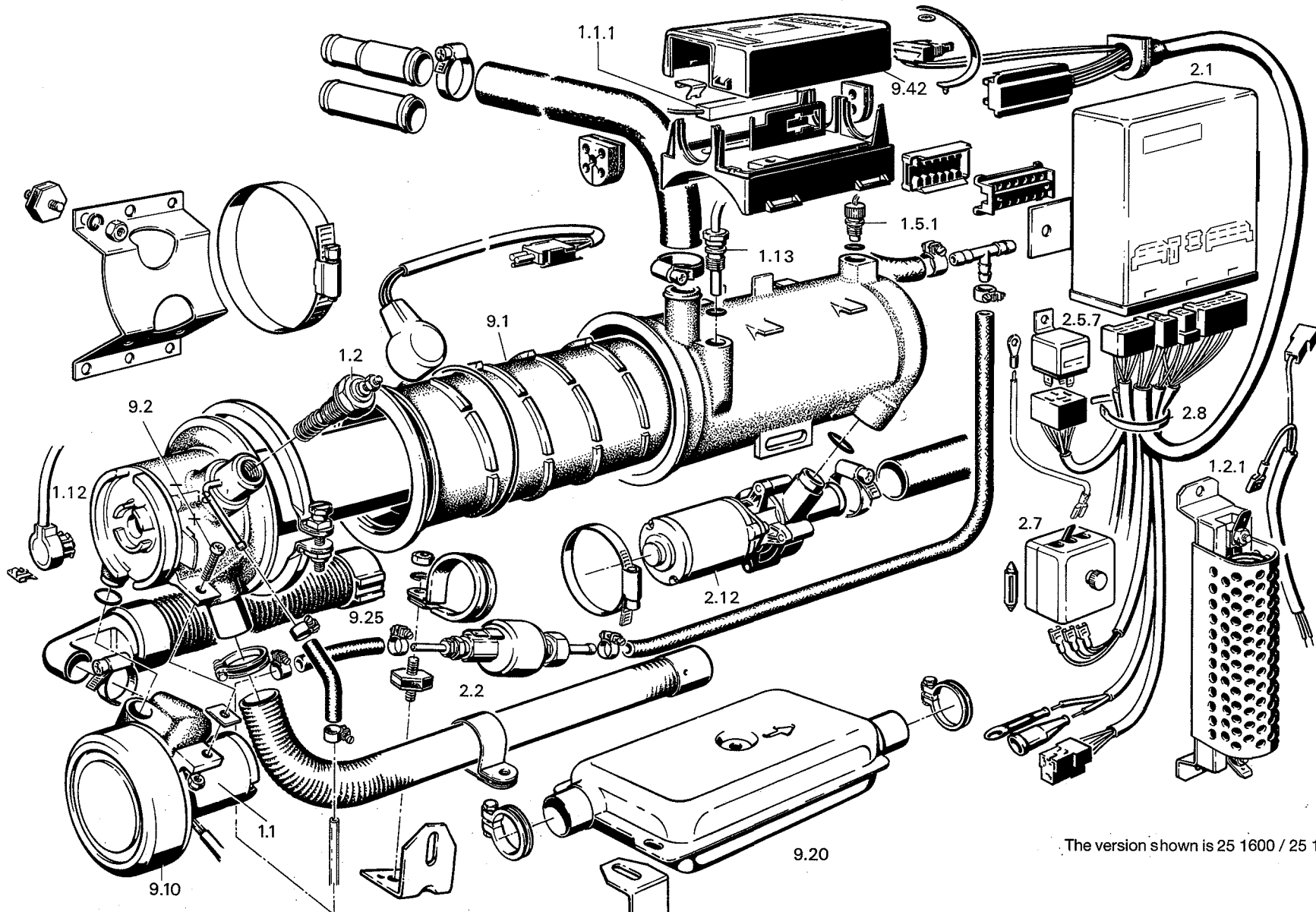

The version shown is 25 1600 / 25 1671

- 1.1 Burner motor
- 1.1.1 Series resistor for partial load
- 1.2.1 Series resistor for glow plug at 24 V
- 1.5.1 Safety thermal cutout fuse
- 1.12 Flame sensor

- 1.13 Temperature sensor
- 1.2 Glow plug
- 2.1 Control unit
- 2.2 Fuel metering pump
- 2.5.7 Relay for switching on vehicle blower

- 2.7 Fuse box
- 2.8 Cable harness
- 2.12 Water pump
- 9.1 Heat exchanger
- 9.2 Combustion chamber
- 9.10 Combustion air blower

- 9.20 Silencer for exhaust
- 9.25 Silencer for combustion air
- 9.42 Cap



Repair procedures

1. Removing and installing the glow plug
2. Taking off putting back the cap
For repair procedures 3-9, take off the cap and remove the 12-pole plug
3. Removing and installing the 12-pole plug
4. Removing and installing the temperature sensor
5. Removing and installing the flame sensor
6. Removing and installing the safety thermal cutout switch
7. Removing and installing the partial-load resistor
8. Removing and installing the water pump
9. Removing and installing the combustion air blower
10. Removing and installing the burner
11. Removing and installing the heat exchanger
12. Removing the cap complete
13. Bleeding the cooling water system

1. Removing and fitting the glow plug

Remove the plug cap, loosen the M 4 hex. nut and remove the plug cable.
Unscrew the glow plug (WAF 19).

Important

With diesel heaters, use an angled hook to scrape free and clean the hole for the plug inside the plug connection piece before inserting the glow plug.

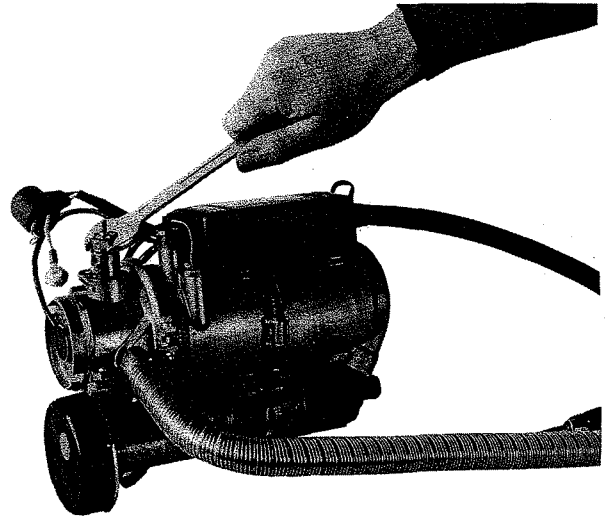
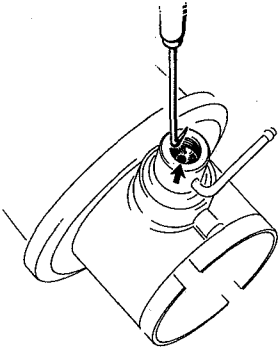

Fig. 1

2. Removing and fitting the cover cap

Snap open the cover cap with a screwdriver and then remove it.

Important

The cover cap must be fitted splashwater-tight, so ensure proper seating of all grommets.

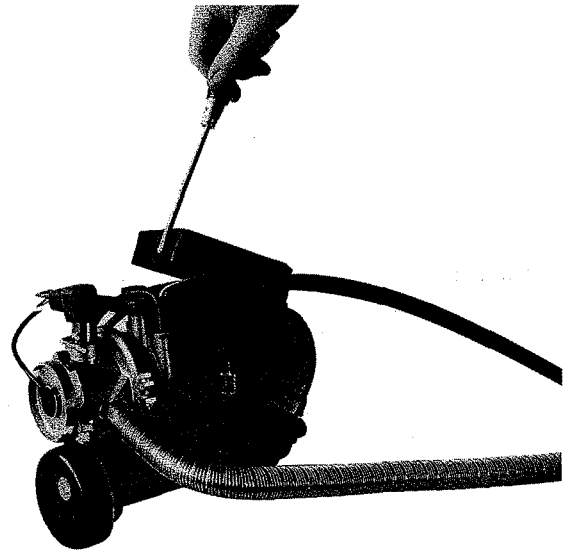
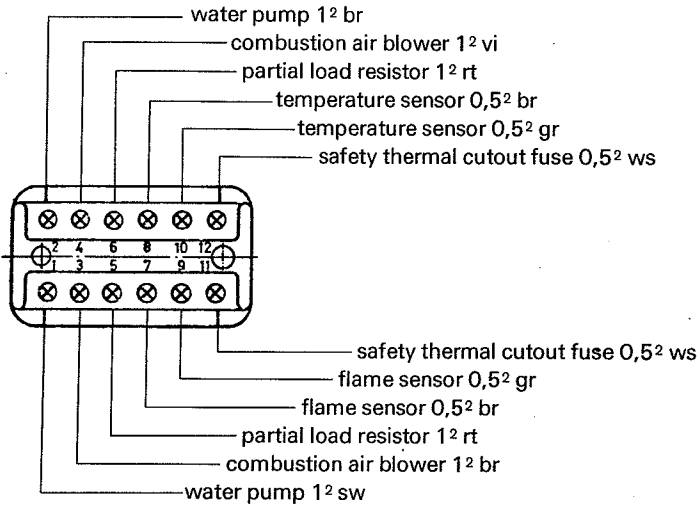

Fig. 2

3. Removing and installing the 12-pole plug



Sketch 1

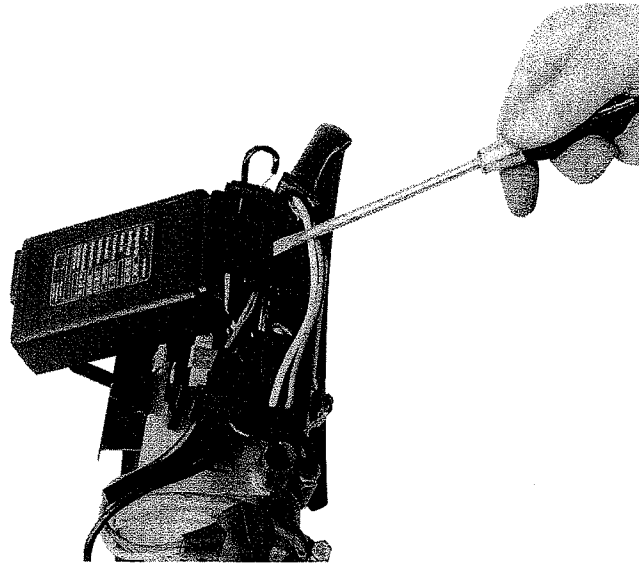

Fig. 3

4. Removing and installing the temperature sensor

Removal: Before removal, reduce the excess pressure in the cooling system by opening the radiator filler cap.

To prevent the coolant from flowing out, pinch the water supply and return hoses shut.

Take plug pins out of the plug housing (Terminal 8/10) and nip off the pins (see sketch 1).

Unscrew temperature sensor (WAF 13).

Installation: Screw in the temperature sensor, pass cable with plug pins through the grommet to the plug housing.

Lay cable in plug housing and insert plug pins (see sketch 1).

See repair procedure 13 for bleeding the water circuit.

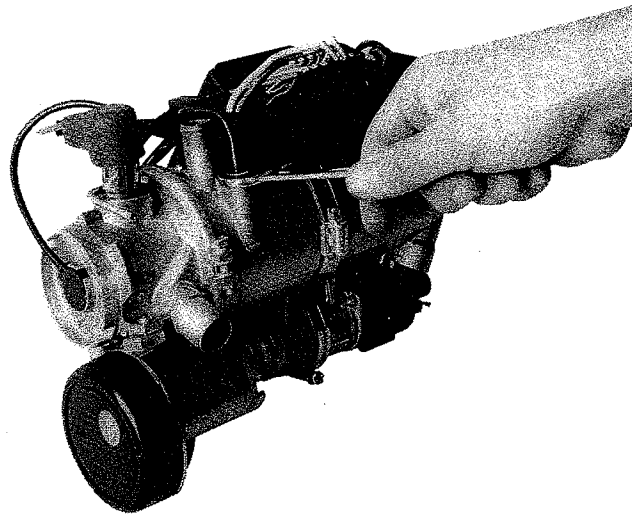

Fig. 4

5. Removing and installing the flame sensor

Removal: Take plug pins out of the plug housing (Terminal 7/9) and nip off the pins (see sketch 1). Remove clamp and take out the flame sensor through the burner cover.

Installation: Insert the flame sensor into burner cover and fasten it with clamp.

Pass cable with plug pins through the grommet to the plug housing.

Lay cable in plug housing and insert plug pins (see sketch 1).

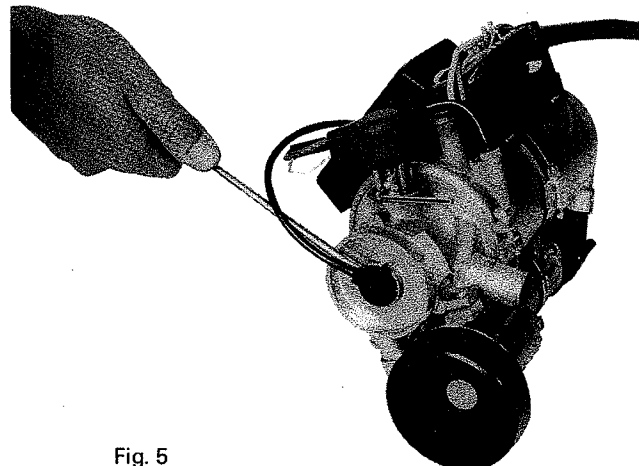
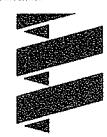

Fig. 5



6. Removing and installing the safety thermal cutout switch

Removal: Before removal, reduce the excess pressure in the cooling system by opening the radiator filler cap.
To prevent the coolant from flowing out, pinch the water supply and return hoses shut.
Take plug pins out of the plug housing (Terminal 11/12) and nip off the pins (see sketch 1).
Unscrew the safety thermal cutout fuse.

Installation: Before inserting the safety thermal cutout fuse, smear the thread and the O-ring with lubricant (e.g. silicone grease, glycerine, Vaseline).
Screw in the safety thermal cutout fuse by hand until resistance can be clearly felt and the fuse is up against the contact surface of the heat exchanger.
Pass cable with plug pins through the grommet to the plug housing.
Lay cable in plug housing and insert plug pins (see sketch 1).
See repair procedure 13 for bleeding the water circuit.

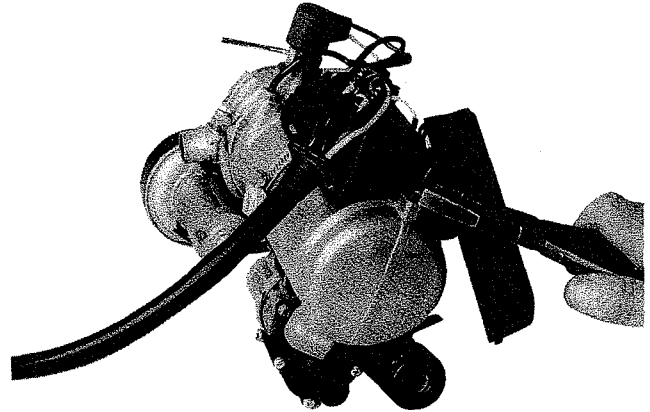

Fig. 6

7. Removing and installing the partial load resistor

Removal: Pull plug pins out of the plug housing (Terminal 5/6) and nip off the plug pins (see sketch 1). Remove both holding brackets from the partial load resistor and remove the resistor.

Installation: Insert partial load resistor, fit holding brackets.
Pass cable with plug pins to the cable housing.
Lay cable in plug housing and insert plug pins (see sketch 1).

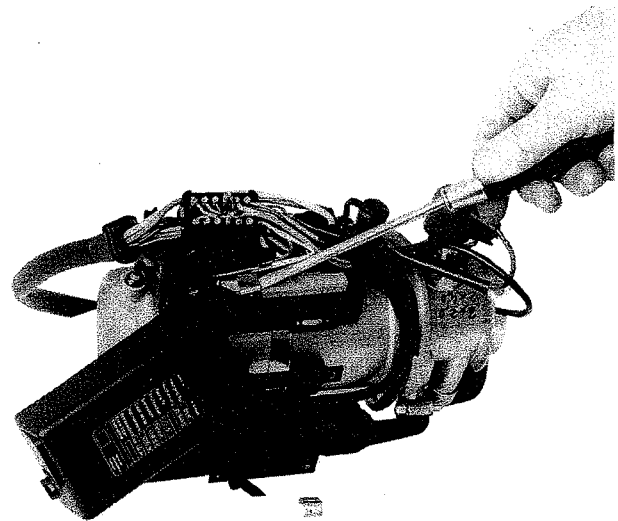

Fig. 7

8. Removing and installing the water pump

Removal: Before removal, reduce the excess pressure in the cooling system by opening the radiator filler cap. To prevent the coolant from flowing out, pinch the water supply and return hoses shut.

Take plug pins out of the plug housing (Terminal 1/2) and nip off the pins (see sketch 1).

Undo fastening clip for water pump and remove water pump.

Installation: Smear new O-ring with lubricant (e.g. silicone grease, glycerine, Vaseline) and slip it over the water connection.

Pass cable with plug pins through the grommet to the plug housing.

Lay cable in plug housing and insert plug pins (see sketch 1).

See repair procedure 13 for bleeding the water circuit.

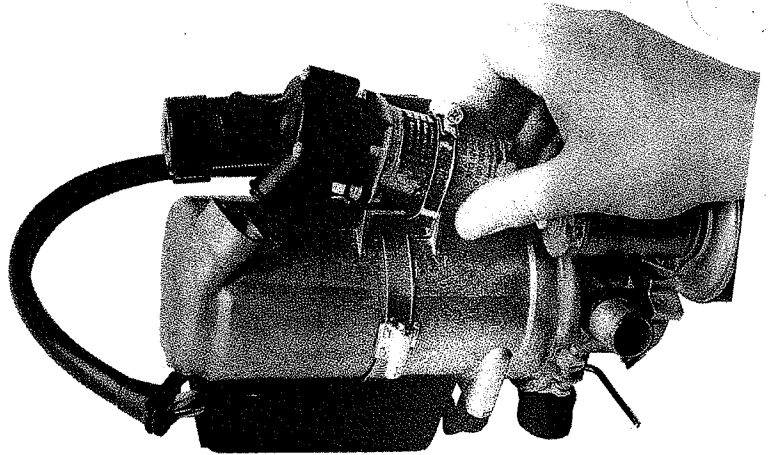

Fig. 8

9. Removing and installing the combustion air blower

Removal: Take plug pins out of the plug housing (Terminal 3/4) and nip off the pins (see sketch 1). Undo clip and fastening strip from combustion air silencer and remove the silencer.

Undo Philips head screw from combustion air blower and remove the blower.

Installation: Insert O-ring into the blower connection piece. Insert blower and screw it tight.

Fasten silencer with clip and fastening strip.

Lay cable in plug housing and insert plug pins (see sketch 1).

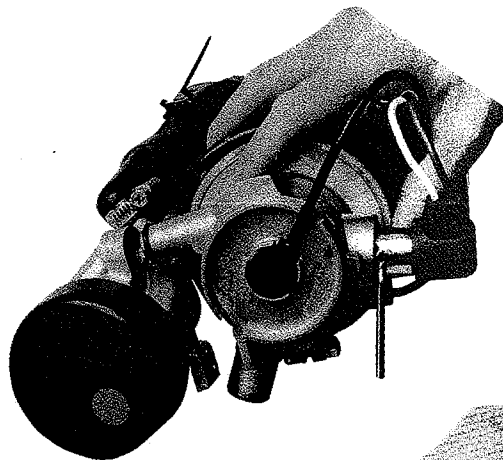

Fig. 9

10. Removing and installing the combustion chamber

Function: An ignitable mixture is formed in the combustion chamber, ignited there by the glow plug, and develops a stable flame very shortly.

Removal: Remove the heater after letting off the excess pressure in the cooling system.

See repair procedure 9 for removing the combustion air blower.

See repair procedure 1 for undoing the plug cable.

See repair procedure 5 for removing the flame sensor.

Detach fuel hose.

Remove exhaust pipe.

Undo clamping clip and remove burner.

Installation: In reverse order.

Fit O-ring onto connection on combustion chamber.

See repair procedure 13 for bleeding the water circuit.

Check tightness in a test run (leaked air).

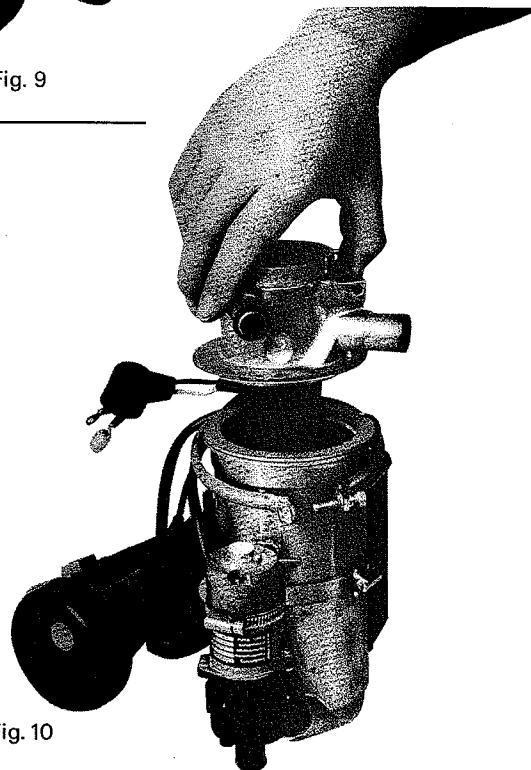

Fig. 10



11. Removing and installing the heat exchanger

Removal: Remove the heater after letting off the excess pressure in the cooling system. See repair procedure 10 for removing the combustion chamber. Slightly unscrew (one turn) the safety thermal cutout switch in order to lift it off the heat exchanger. Lift heat exchanger out of the water cooling jacket using a screwdriver until the O-ring becomes visible; then, so as not to damage the temperature sensor, remove the heat exchanger by turning it anticlockwise.

Installation: Replace O-ring. Place heat exchanger in the water cooling jacket and turn it until the catch engages. See repair procedure 10 for installing the combustion chamber. See repair procedure 6 for screwing in the safety thermal cutout fuse. See repair procedure 13 for bleeding the water circuit.

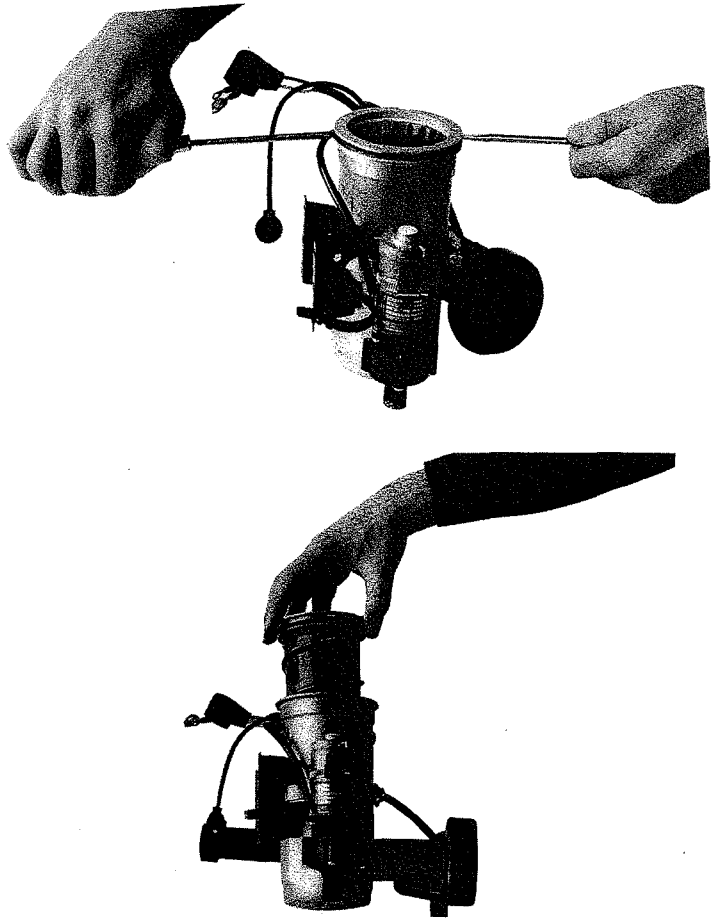

Fig. 11

12. Removing the cap complete

Removal: Taking off the cap
Detach 12-pole plug.
Detach 2-pole plug.
Remove partial load resistor (see p. 13).
Remove all grommets.
Take cap off water cooling jacket using screwdriver (see p. 11).

Installation: Installation is in reverse order.

IMPORTANT: The cap must be fitted so that it is splash-water proof, so ensure that all grommets are properly positioned.

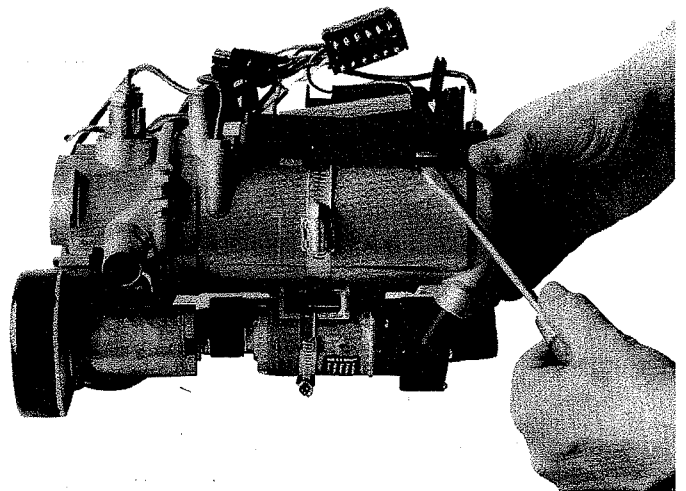

Fig. 12

13. Bleeding the cooling water system after heater installation

Set heater lever full in the "Warm" setting.
Top up cooling water.
Run the vehicle engine until the radiator thermostat has opened.

To bleed the heating system, start the water pump of the heater via terminal 6 on the control unit (6-pole plug) (positive at terminal 6).
If necessary, top up cooling water.

Please refer also to the vehicle manufacturer's instructions on bleeding the water circuit.

Measuring the fuel quantity

IMPORTANT: Only measure the fuel quantity when the battery is sufficiently charged. At least 11/22 V and at most 13/26 V should be applied at the control unit during the measurement.

1. Preparation

Take plug terminal under the heater cap apart and connect a test lamp instead of a glow plug.
Detach fuel line from heater and introduce it into a measuring glass (size 25 cm³). Connect voltmeter to 8-pole plug, terminal 6 (+) and to 6-pole plug, terminal 4 (-), of the control unit. Switch on heater until fuel is being pumped evenly (fuel does not start being pumped for 25 to 55 seconds after switch-on). The fuel line is now filled and bled. Switch off the heater, and empty the measuring glass.

2. Measurement

Switch on heater. Hold the measuring glass at the level of the plug during measurement. Read off the voltage on the voltmeter.

Fuel starts being pumped automatically 25 to 55 seconds after switch-on. Fuel is pumped for 90 seconds. After that, the fuel feed is **automatically** switched off.

Switch off the heater.

Read off the fuel quantity.

3. Evaluation

Using the diagram, read upwards from the measured voltage and horizontally from the fuel quantity pumped during 90 seconds. The intersection of the two lines must be within the two limit curves. If it is not, replace the metering pump.

Fuel measurement

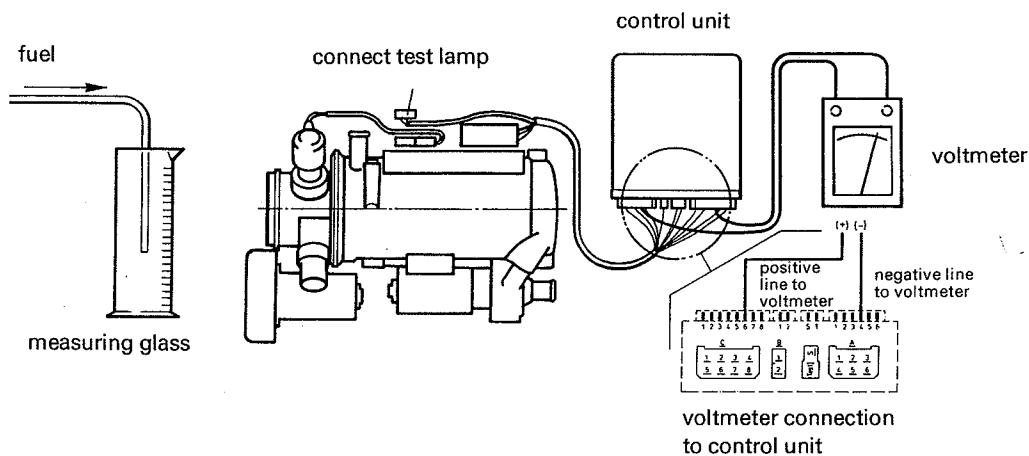

Fuel diagram

90-second measurement

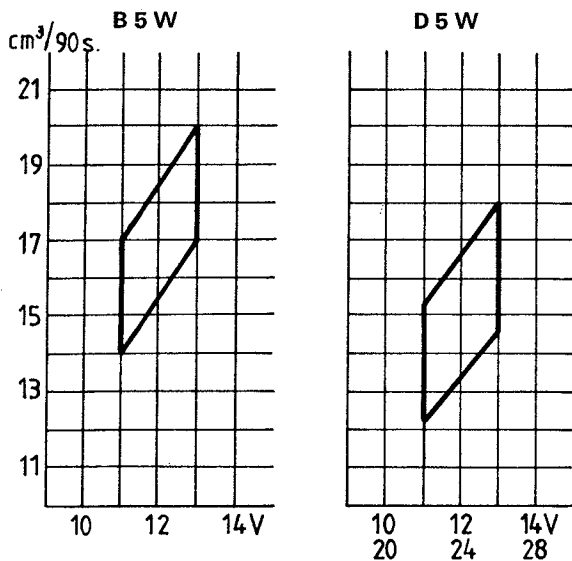

60-second measurement

